

A modern interior space featuring a concrete wall and a staircase with a dark metal handrail. The scene is lit with a cool blue light, creating a clean and architectural atmosphere. A dark blue vertical bar is on the left side of the image.

H O S E T

honet.fi

VÄLISEINÄT

OVET JA JÄRJESTELMÄT

HO
SEET **VÄLISEINÄT**

HOSET

Yritysryhmä, joka valmistaa sisäänkäynti - ja sisäovia, liukujärjestelmiä, huonekaluja, sisustustuotteita.

Hoset ovat sisäovia, liukujärjestelmiä ja väliseiniä. Uusin teknologia lasilla ja alumiinilla sekä ainutlaatuinen, jäljittelemätön tyyli ovat paras ratkaisu moderniin muotoiluun.





HOSSET

AVARUUS

ILMAN

RAJOJA

HOSET

SISÄLTÖ

Väliseinien tyypit **14**

Solmut väliseinien yhdistämiseen **18**

Väliseinät liukujärjestelmällä **24**

Väliseinät täyslasiliukujärjestelmällä **30**

Vaihtoehdot kääntölevyistä väliseinissä **38**

Profiilin väri **42**

Lasivaihtoehdot **43**

















Lineaarinen
väliseinä

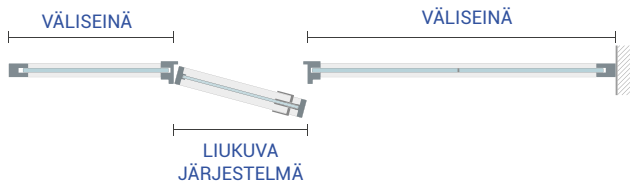

VÄLISEINIEN TYYPIT

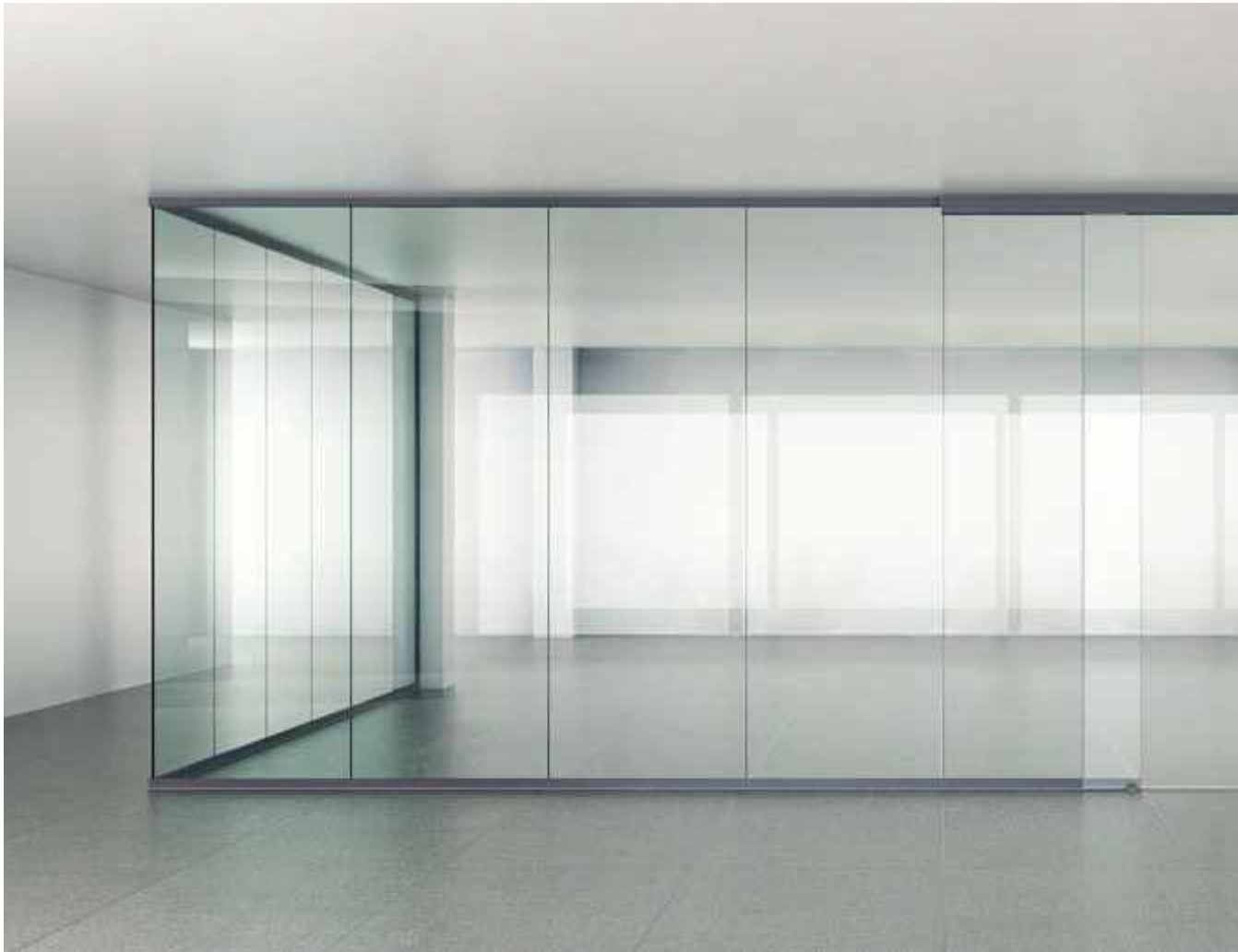

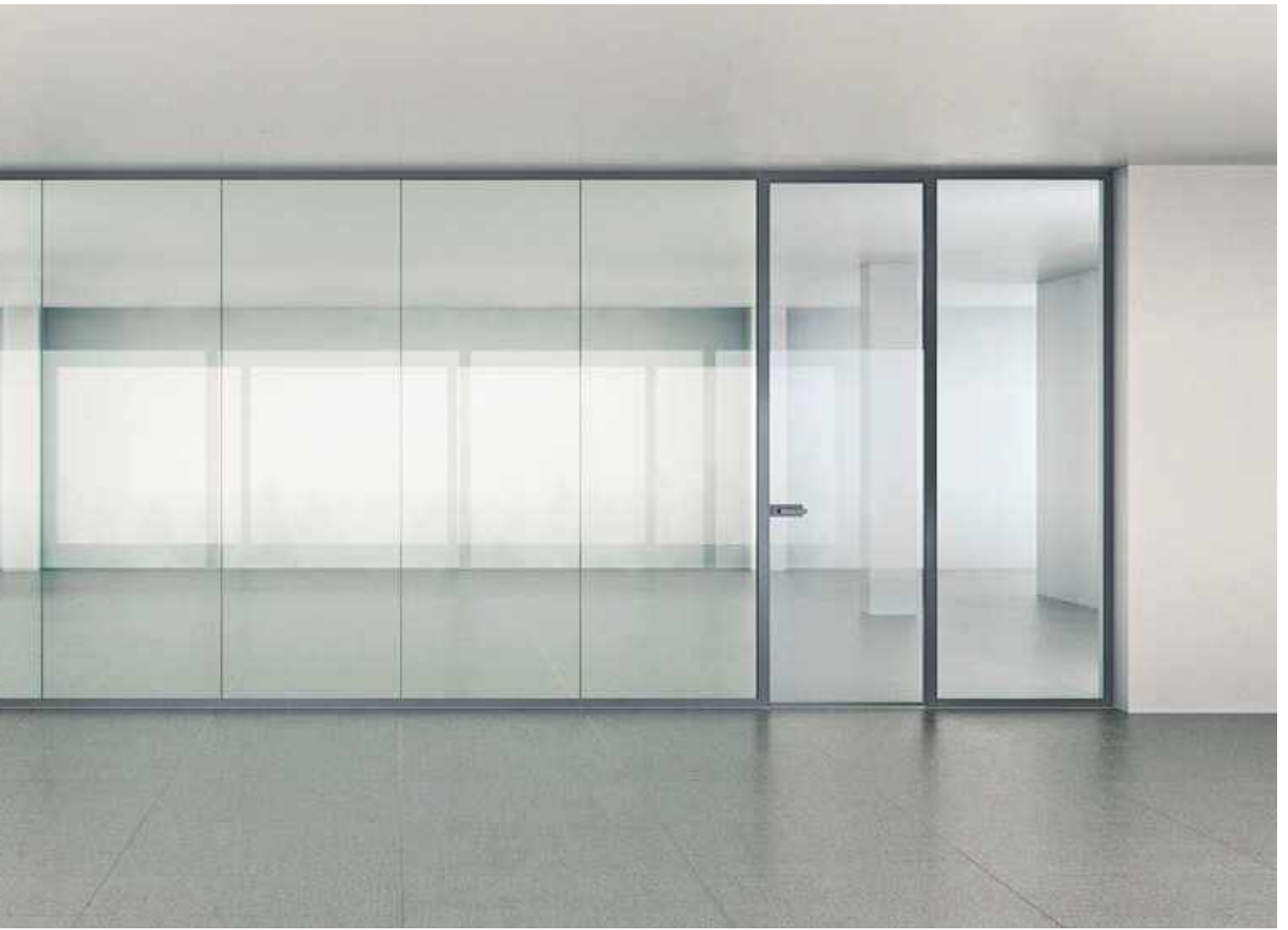

G - kuviollinen väliseinä

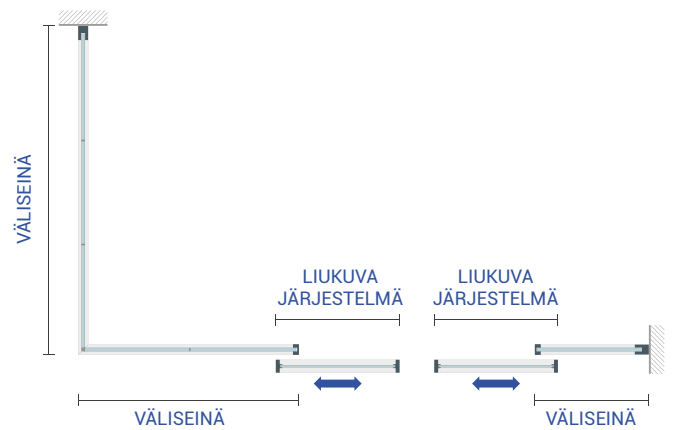

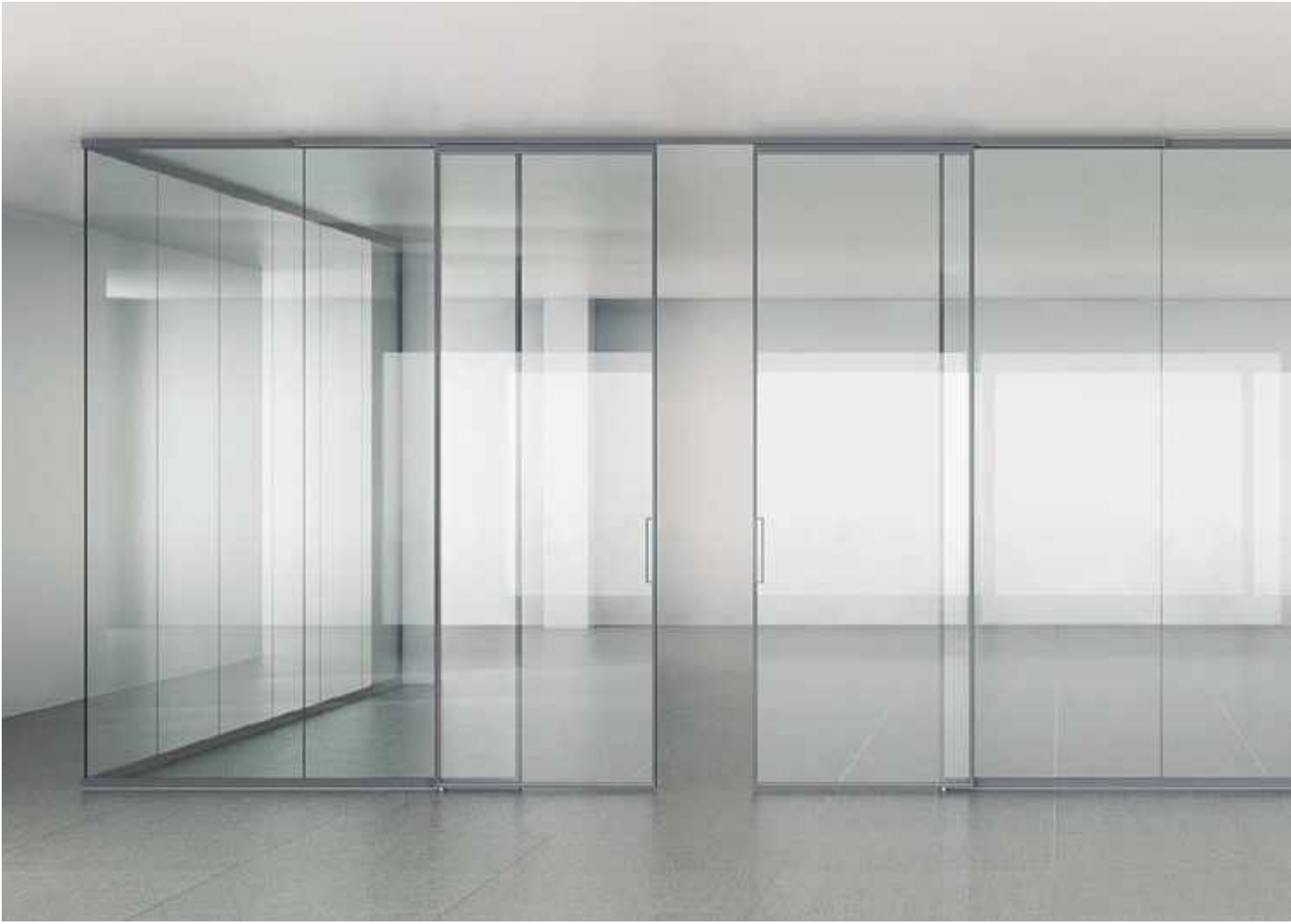

O-kuviollinen väliseinä

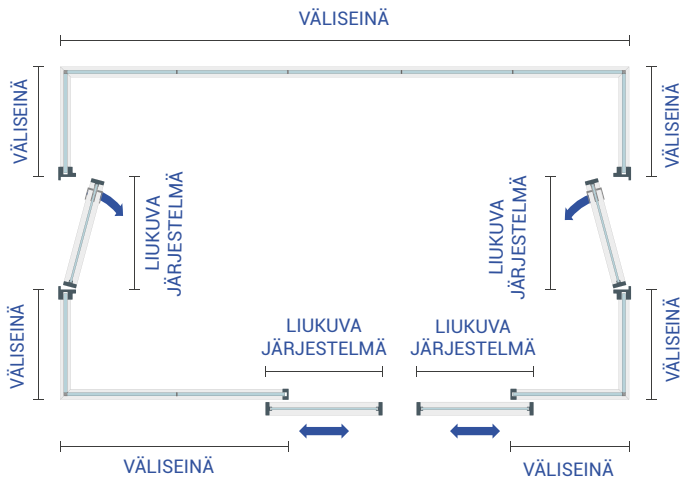



C- kuviollinen väliseinä

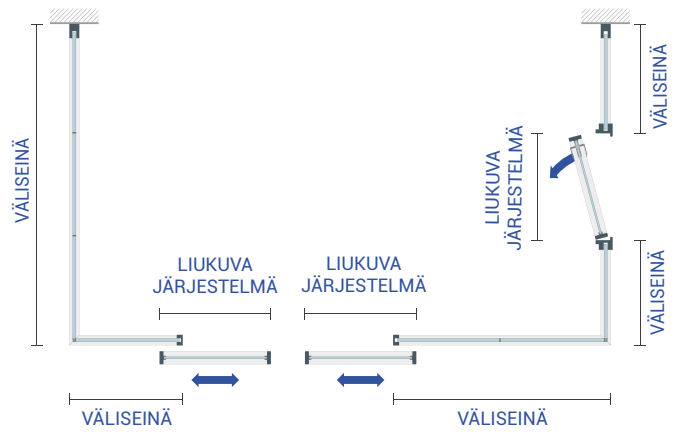

VÄLISEINIEN TYYPIT



1 YHDISTE 90



2 YHDISTE "T"-MUOTOINEN



3 YHDISTE "X"-MUOTOINEN





4 Väliseinän kiinnittäminen seinään



5 Väliseinän ja laatikkoliitännän yhdiste



6 Lasipaneelien liittäminen



1. LASIPANEELIN LIITÄNTÄ

LINEAARINEN VALEVÄLISEINÄ

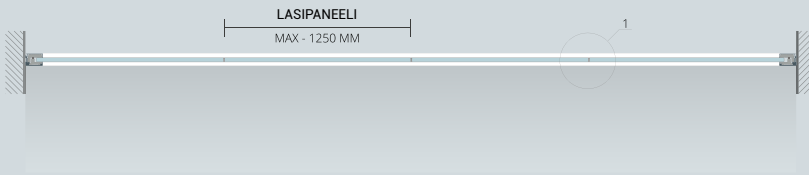

LINEAARINEN VÄLISEINÄ LIUKU/KÄÄNTÖJÄRJESTELMÄLLÄ

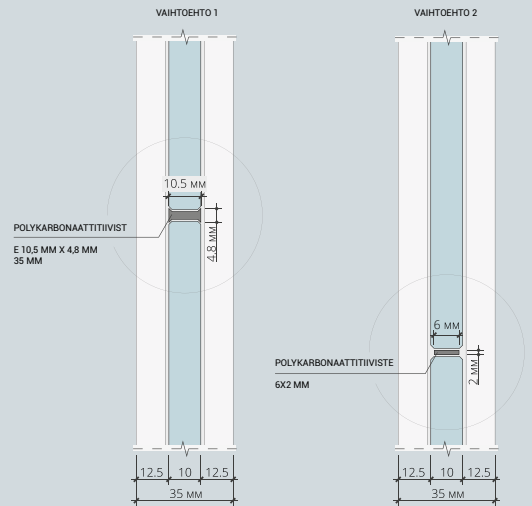
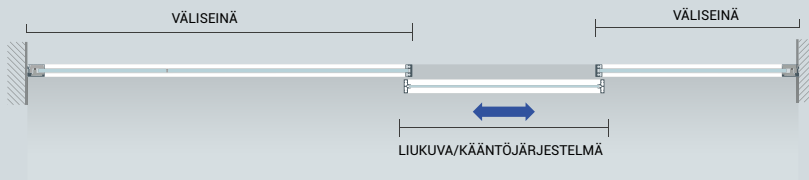

F-MUOTOINEN VÄLISEINÄ VALEVÄLISEINÄ



2. VÄLISEINIEN KULMALIITOKSEN SOLMU

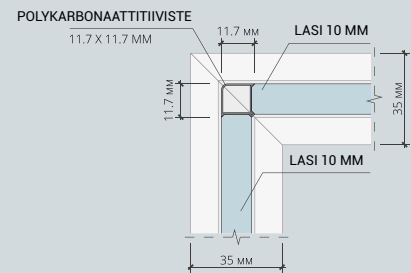

L-MUOTOINEN VÄLISEINÄ LIUKU-/KÄÄNTÖJÄRJESTELMÄLLÄ

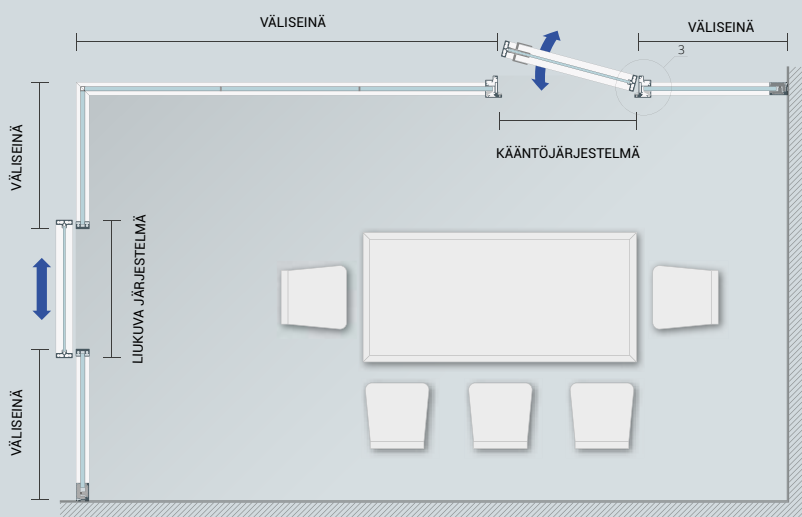

3. OVILEVYN JA VÄLISEINÄN LIITÄNTÄ

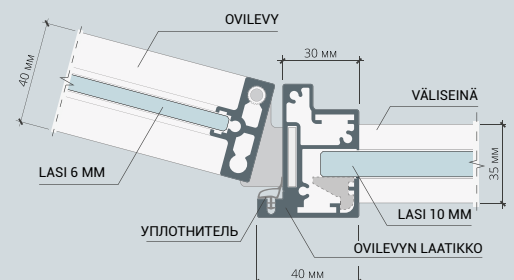

C-MUOTOINEN TYHJÄ VÄLISEINÄ

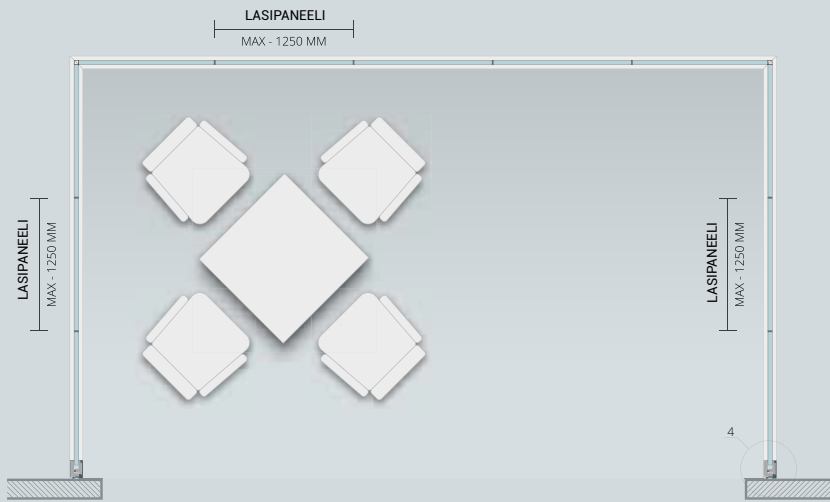

4. VÄLISEINÄN LIITÄNTÄ SEINÄÄN

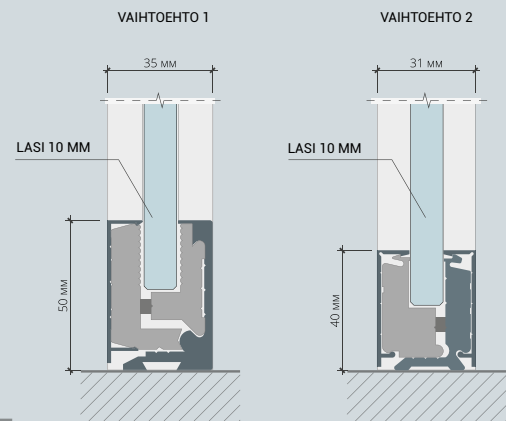

C-MUOTOINEN VÄLISEINÄ LIUKUVA/KÄÄNTÖJÄRJESTELMILLÄ

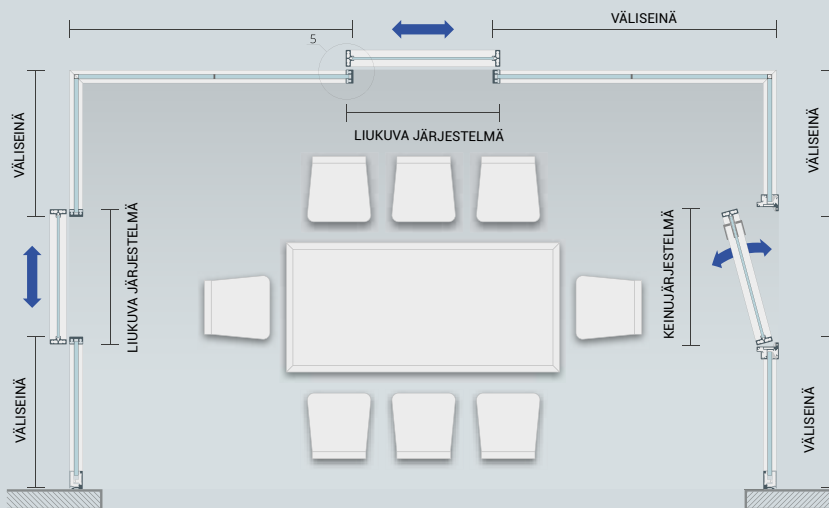

5. OVILEVYN JA VÄLISEINÄN LIITÄNTÄ

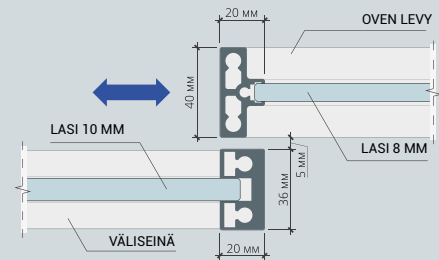

O-MUOTOINEN VÄLISEINÄ LIUKUVA/KÄÄNTÖJÄRJESTELMILLÄ

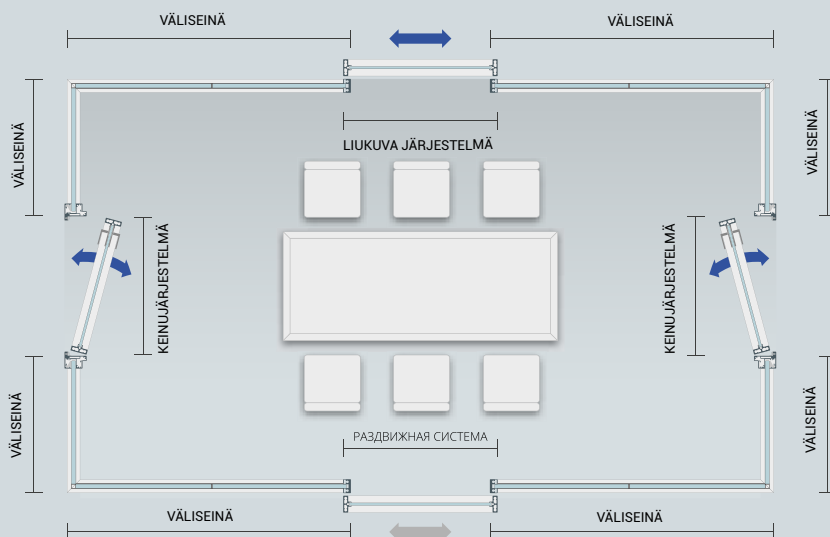

OVILEVY KAMANALLA



VAAKASUUNTAINEN LEIKKAUS

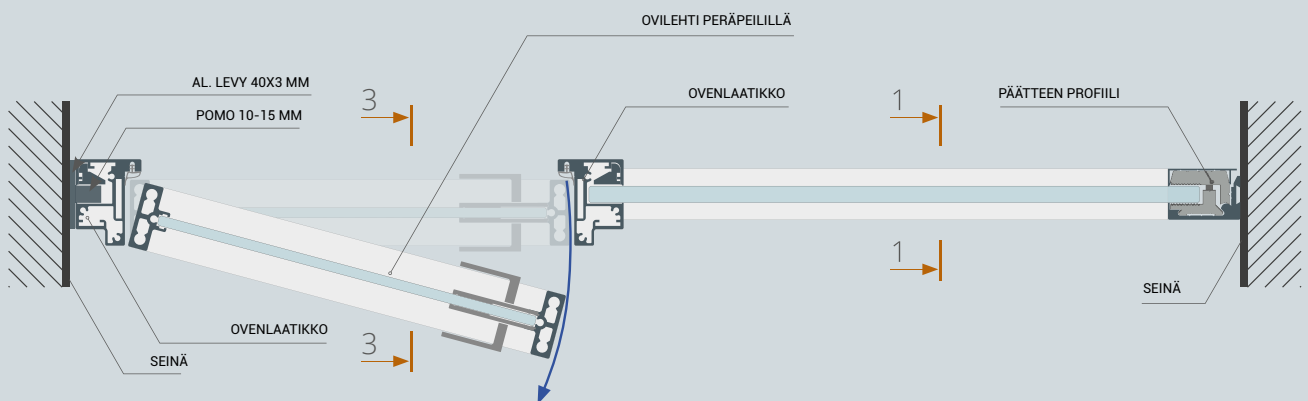
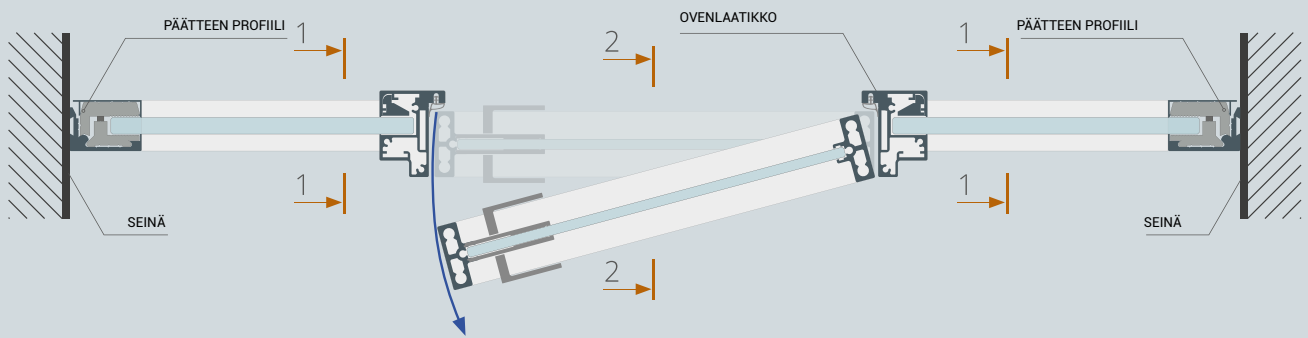
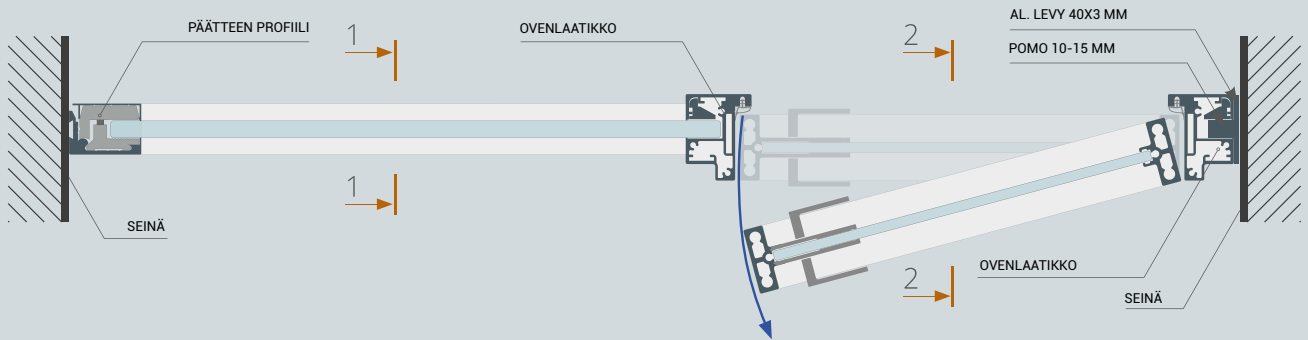

PYSTYSUORA LEIKKAUS

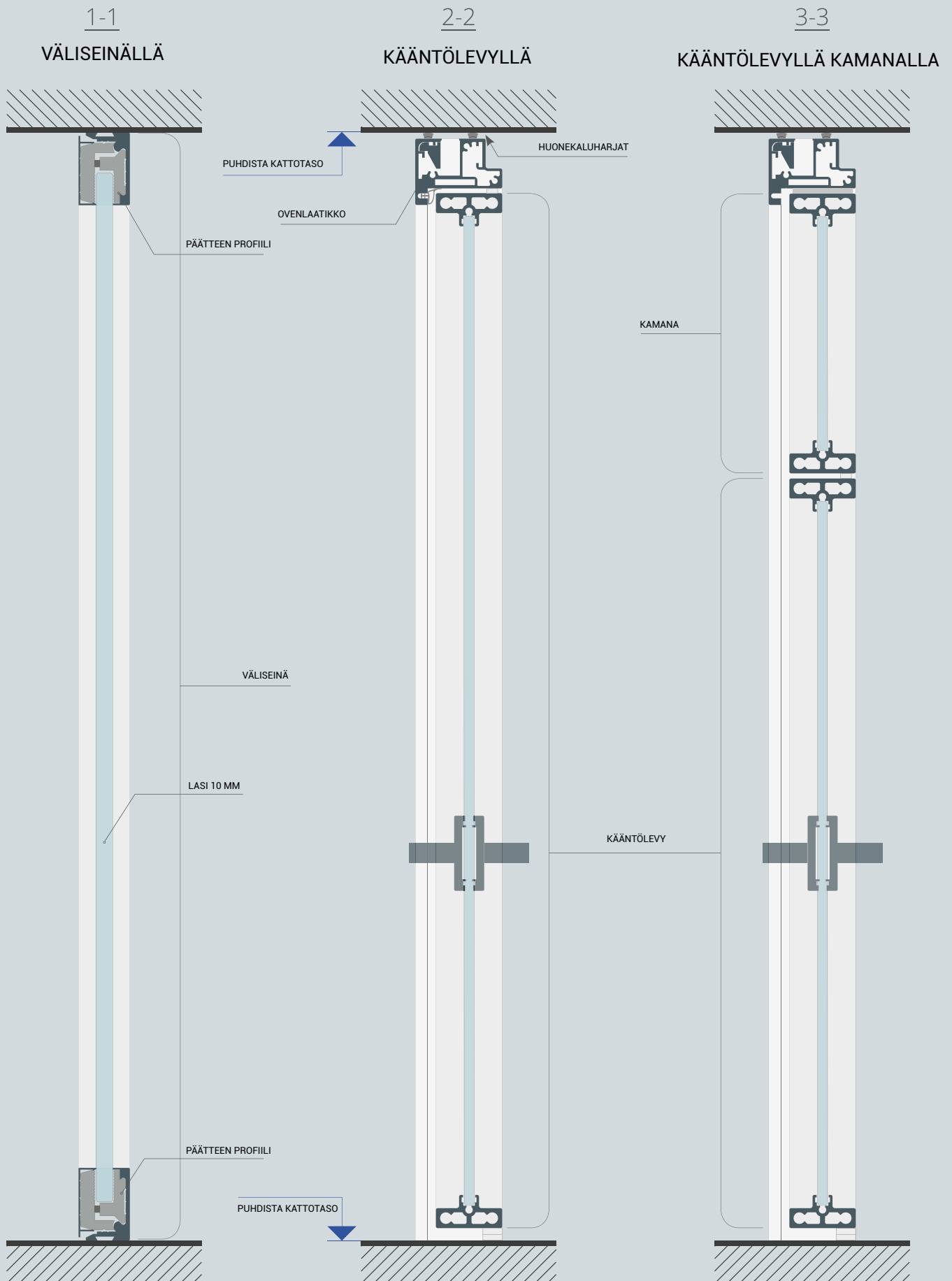

Väliseinä
liukujärjestelmällä

HAFELE SLIDO CLASSIC -JÄRJESTELMÄ

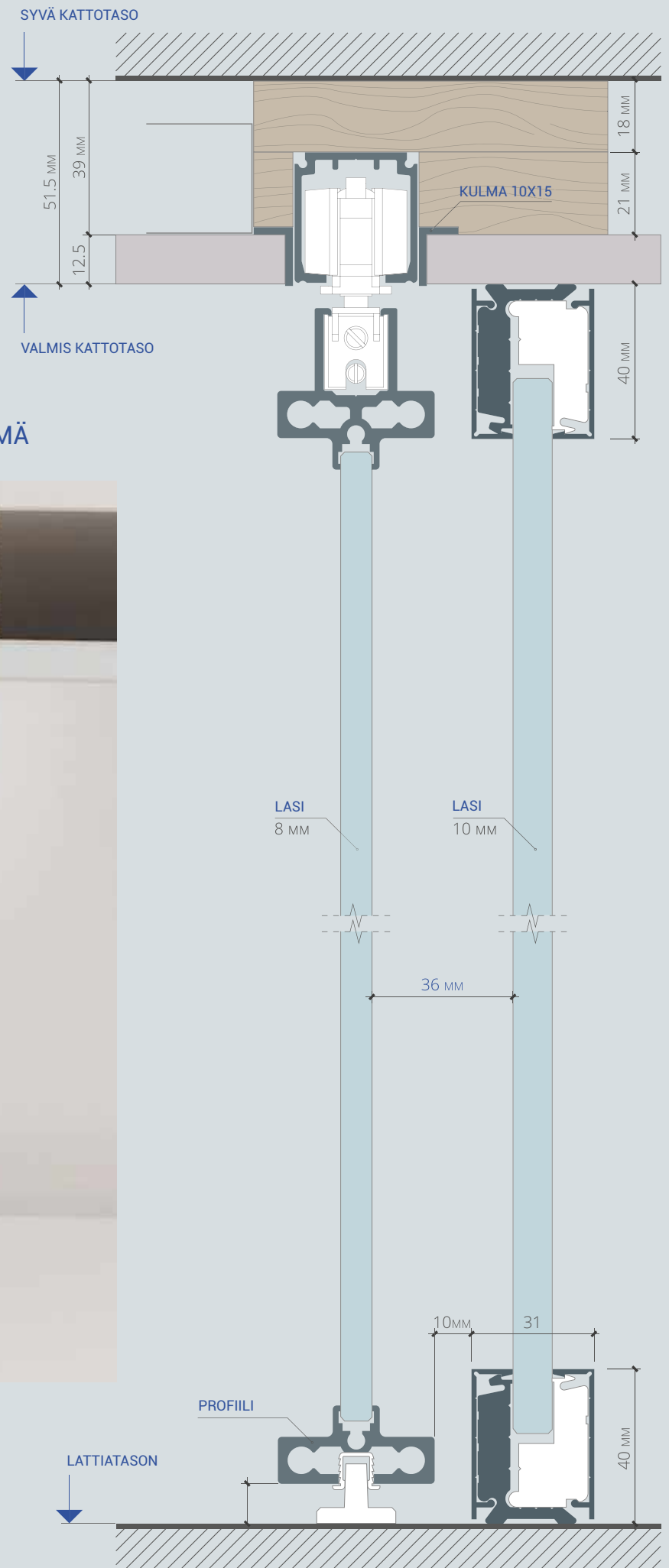



ALU PROFIIILI AVOIMESSA JÄRJESTELMÄSSÄ

VALMIS KATTOTASO

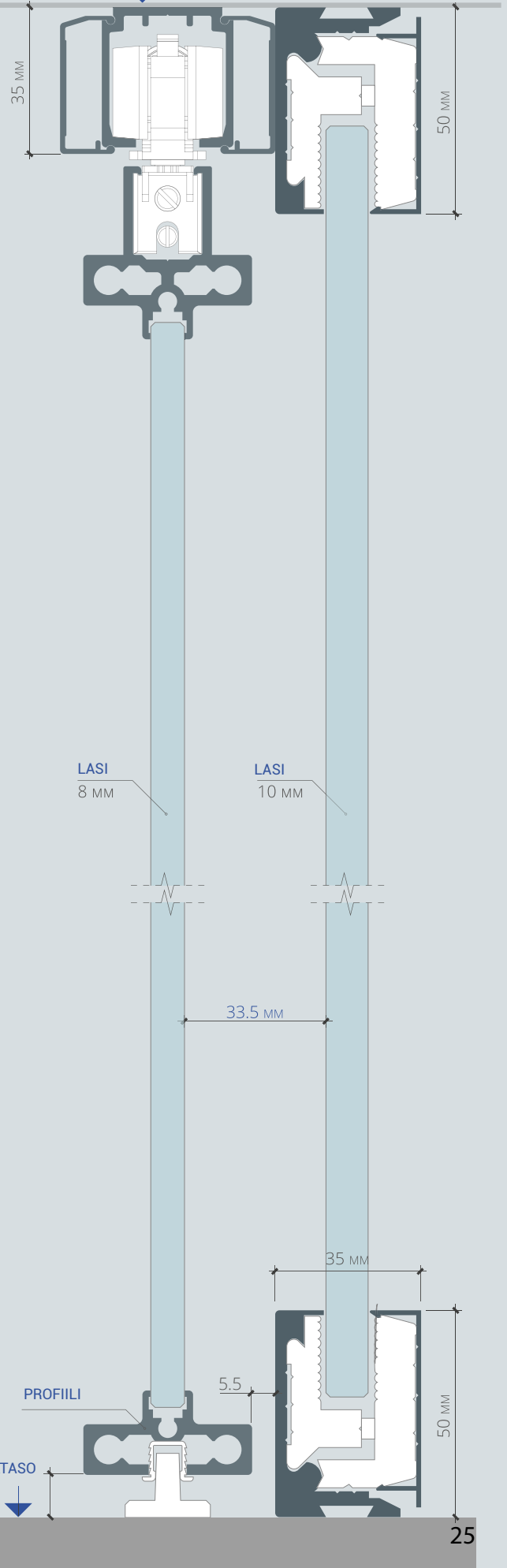

HAFELE SLIDO CLASSIC -JÄRJESTELMÄ



Väliseinä
liukujärjestelmällä

HAFELE SLIDO CLASSIC -JÄRJESTELMÄ

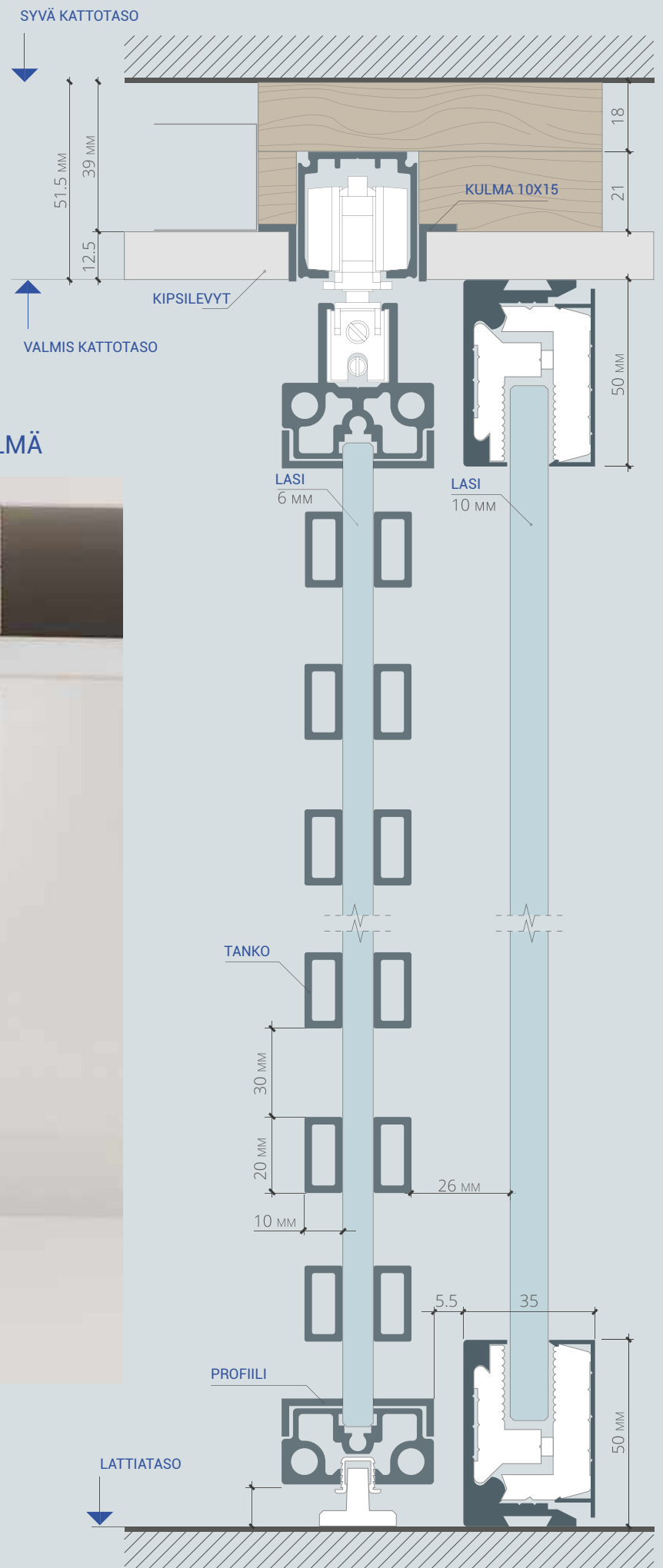

ALU2 PROFIILI AVOIMESSA JÄRJESTELMÄSSÄ

VALMIS KATTOTASO

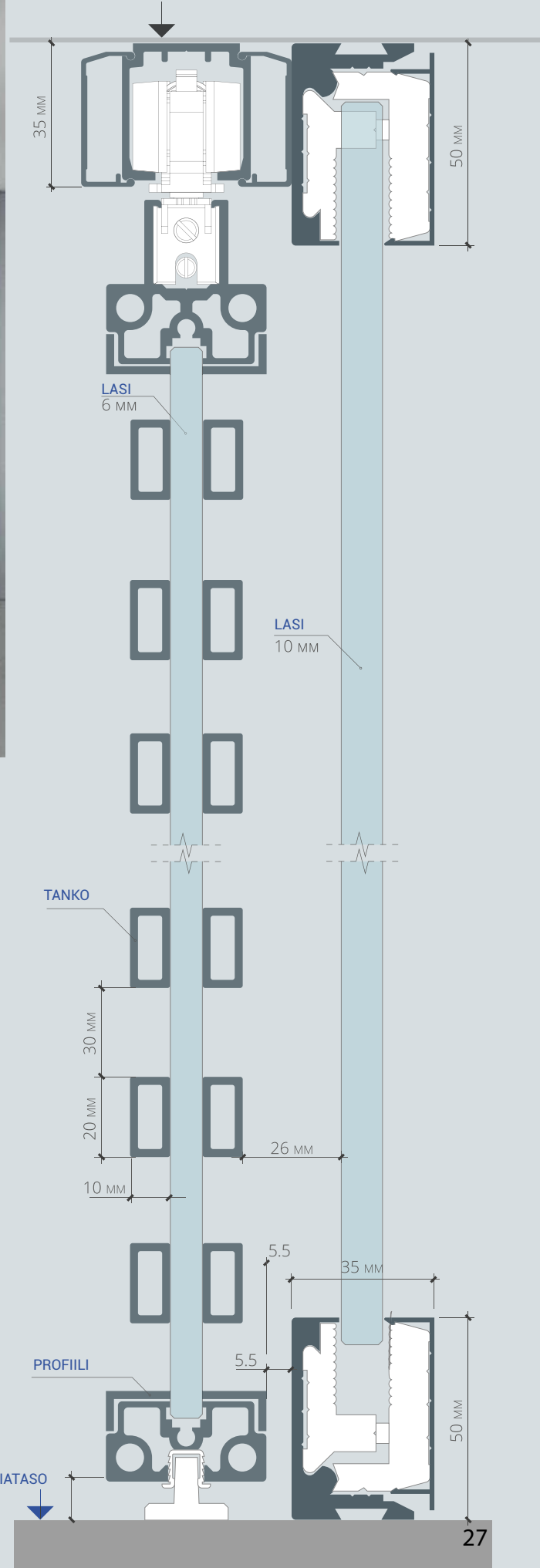

HAFELE SLIDO CLASSIC -JÄRJESTELMÄ



Väliseinä
liukujärjestelmällä

HAFEL SLIDO CLASSIC -JÄRJESTELMÄ - 1

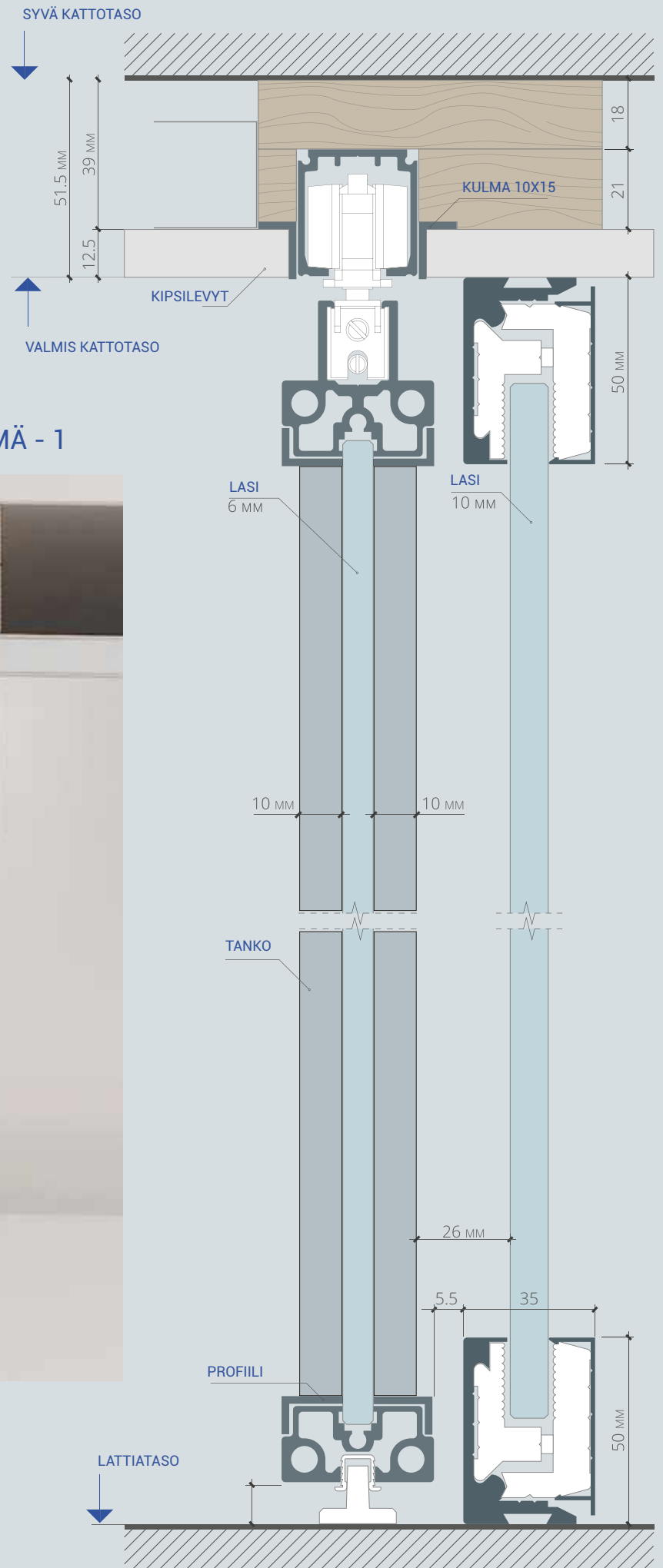

ALU2 PROFIILI AVOIMESSA
JÄRJESTELMÄSSÄ



HAFELE SLIDO CLASSIC 1

VALMIS KATTOTASO

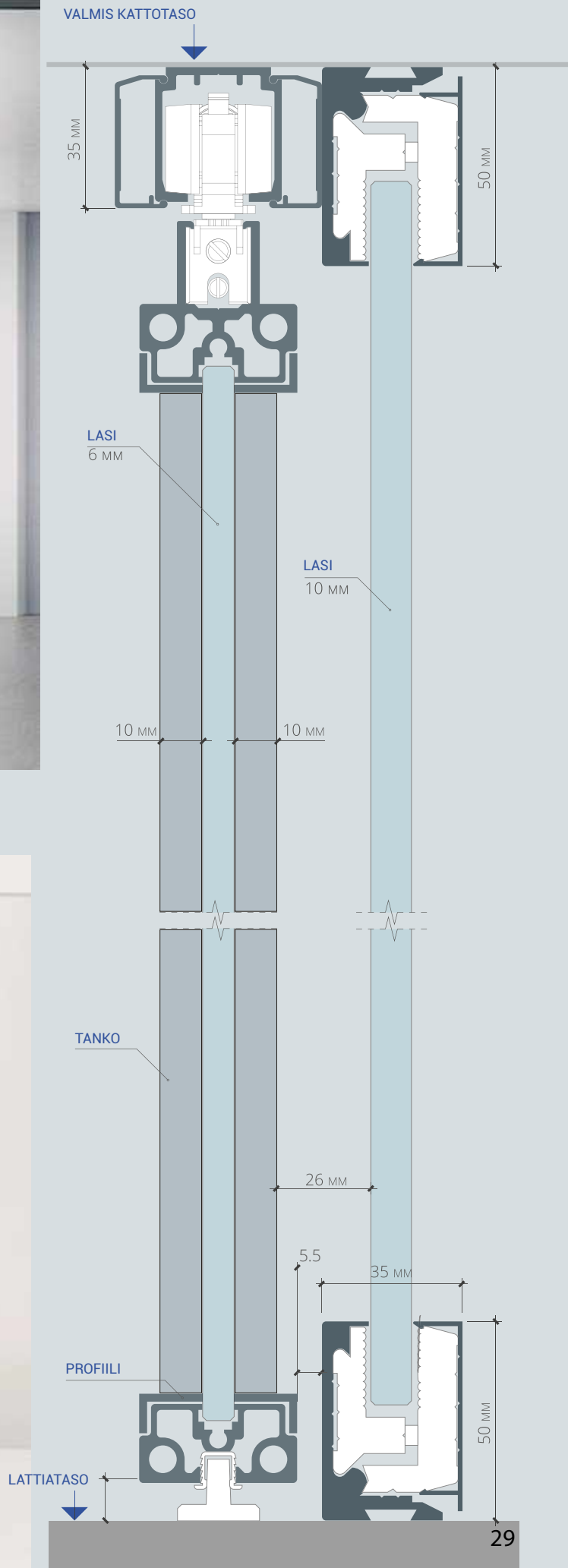

Ovet ja järjestelmät/
Väliseinä
täytlasiliukujärjestelmällä

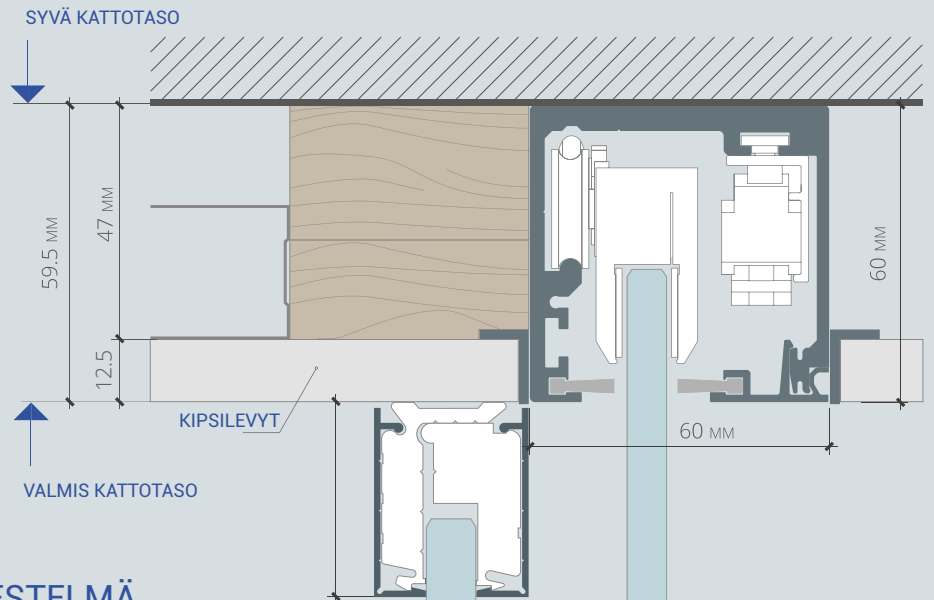

HAFELE SLIDO CLASSIC F -JÄRJESTelmä

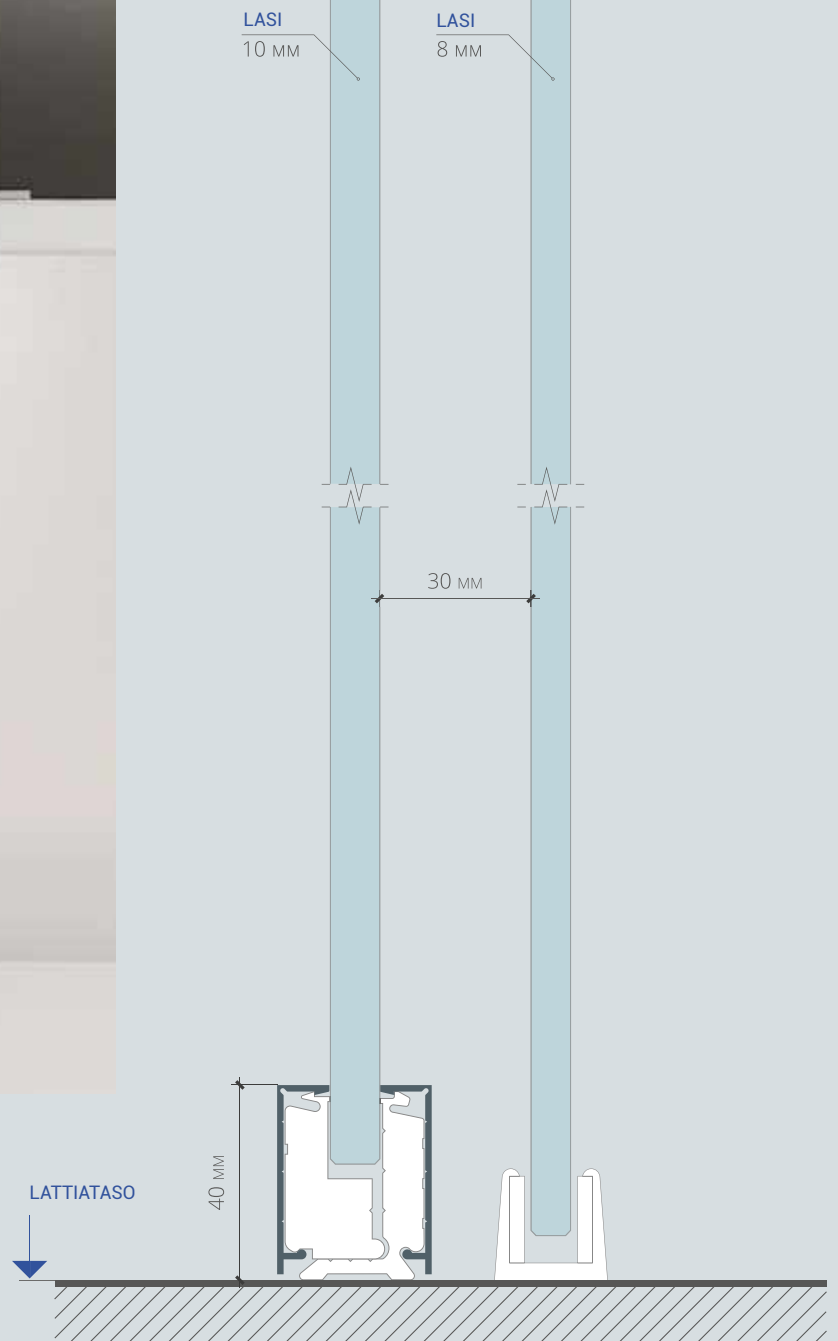

TÄYSLASILEVY AVOIMESSA JÄRJESTELMÄSSÄ



SYVÄ KATTOTASO

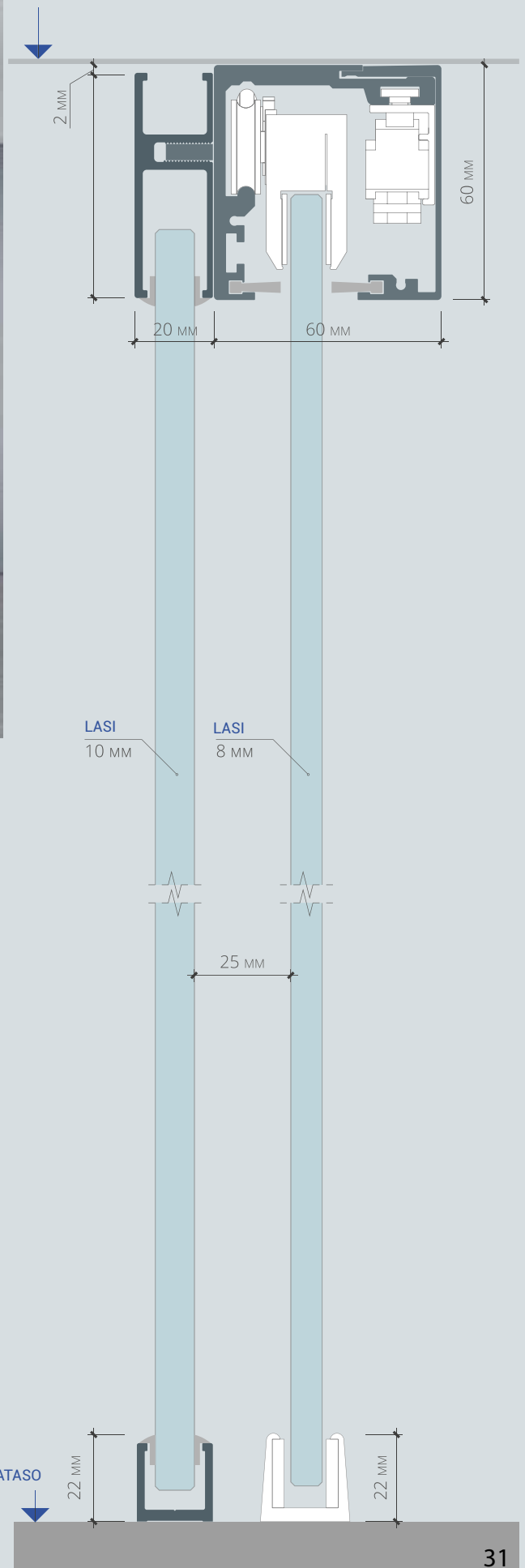

HAFELE SLIDO CLASSIC F -JÄRJESTELMÄ



Väliseinä
täytlasiukujärjestelmällä

Hafele Slido Classic L -järjestelmä

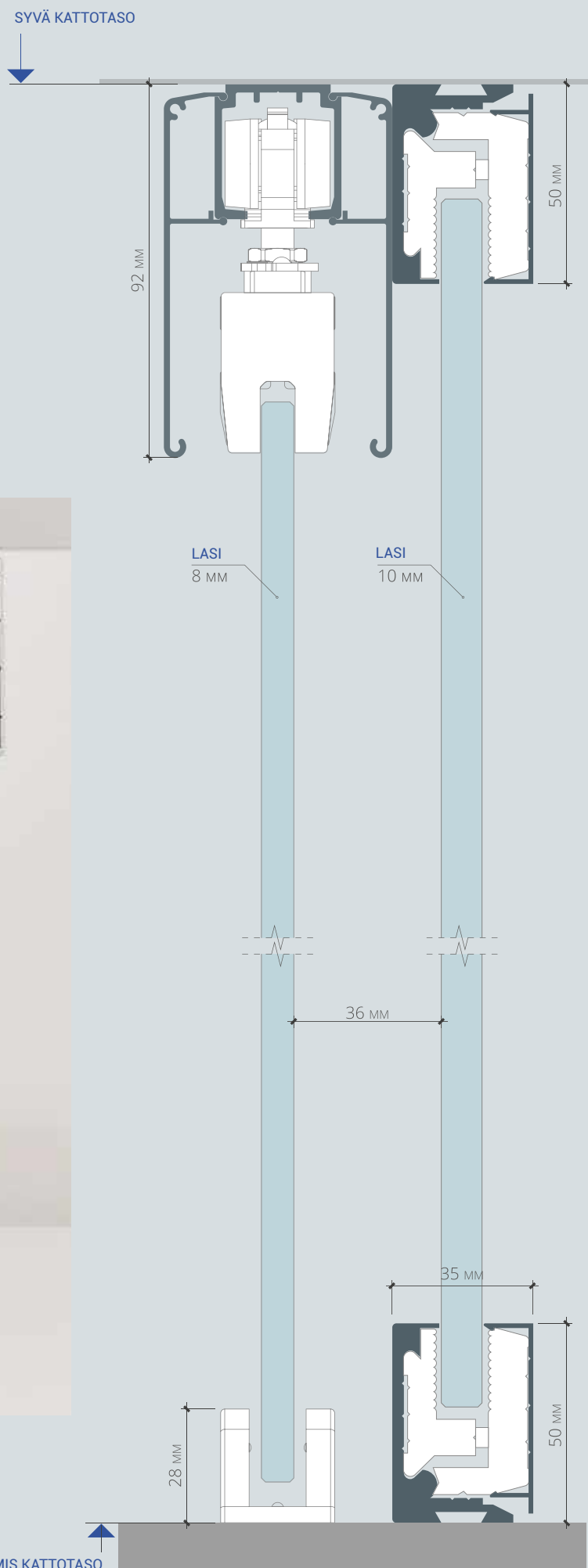
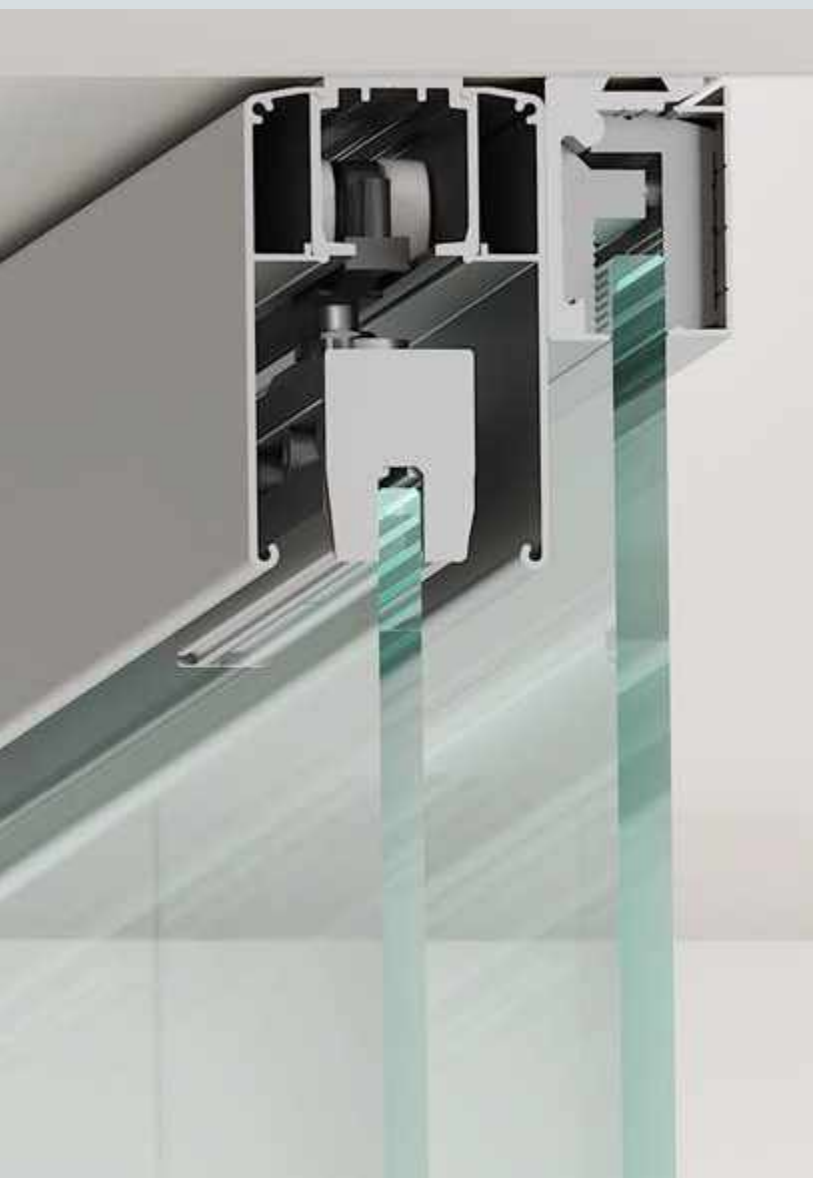

TÄYSLASILEVY AVOIMESSA JÄRJESTELMÄSSÄ



HAFELE SLIDO CLASSIC L -JÄRJESTELMÄ

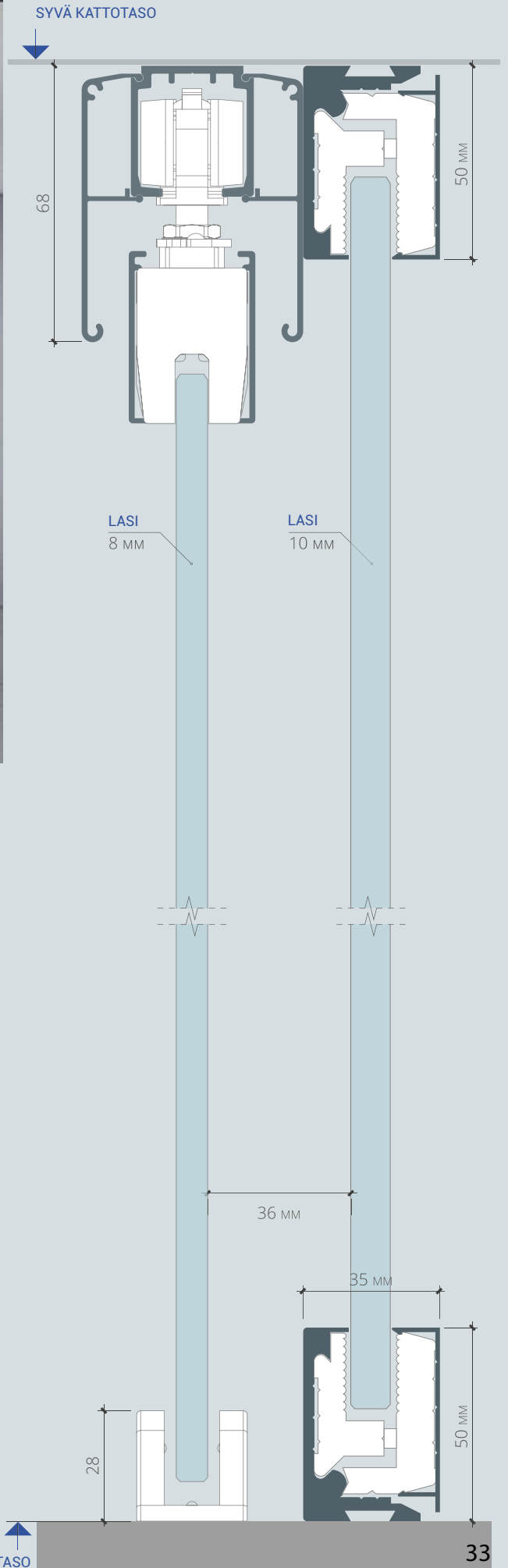

ERILAISIA KÄÄNTÖLEVYJÄ VÄLISEINISSÄ



LEVY PROFILISSA
ALU 1 / KÄÄNTÖ

1

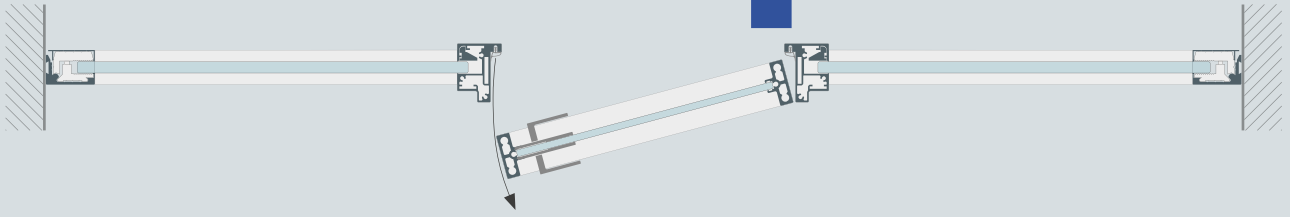

LEVY PROFILISSA
ALU 2 / KÄÄNTÖ

2

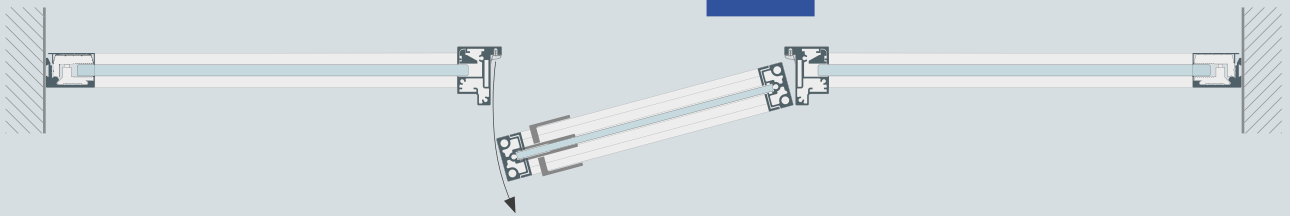

TÄYSLASILEVY
OVENLAATIKOSSA / KÄÄNTÖ

3

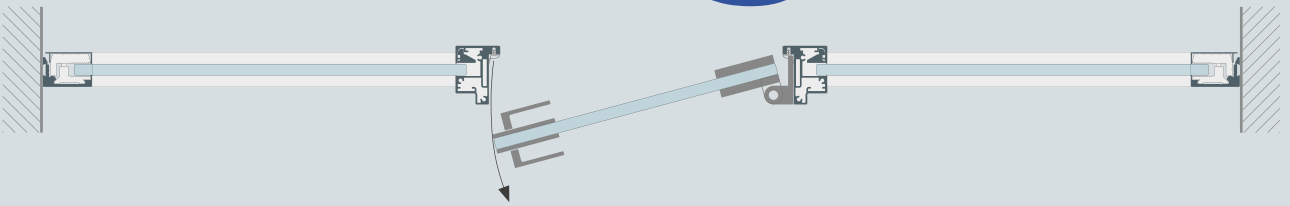

TÄYSLASILEVY ILMAN
OVENLAATIKKOA / KÄÄNTÖ

4

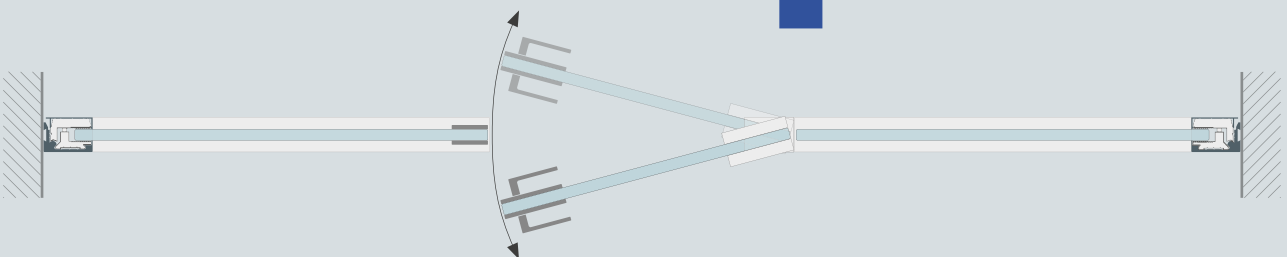

1. Levy profilissa ALU 1 / Kääntö

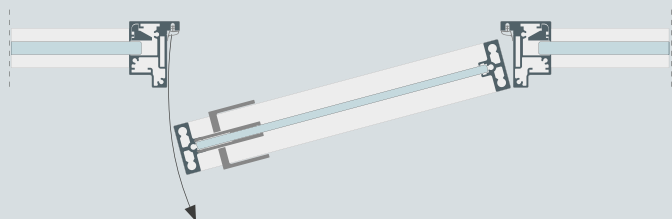

2. Levy profilissa ALU 2 tangoilla

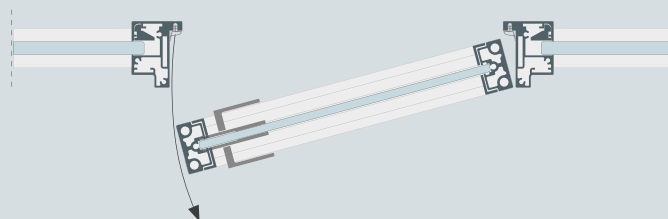
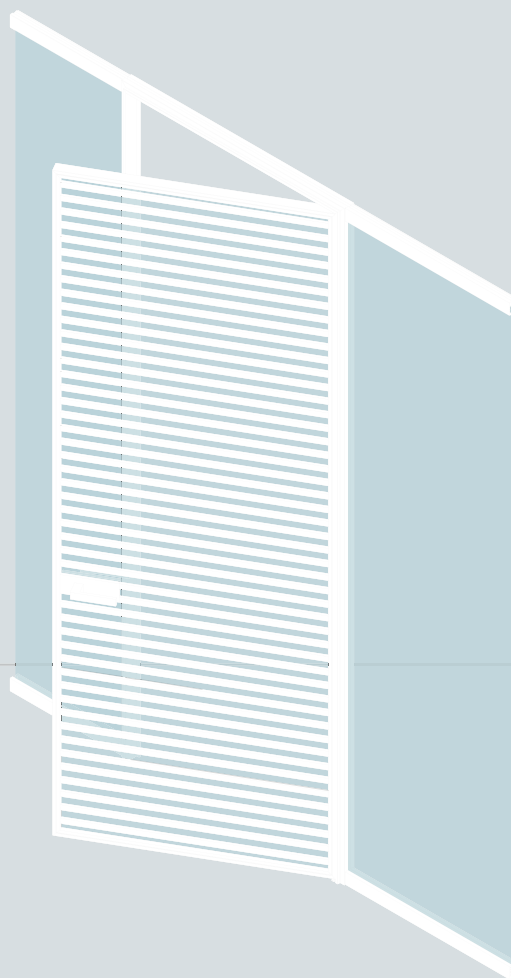

3. Täysslasilevy laatikossa

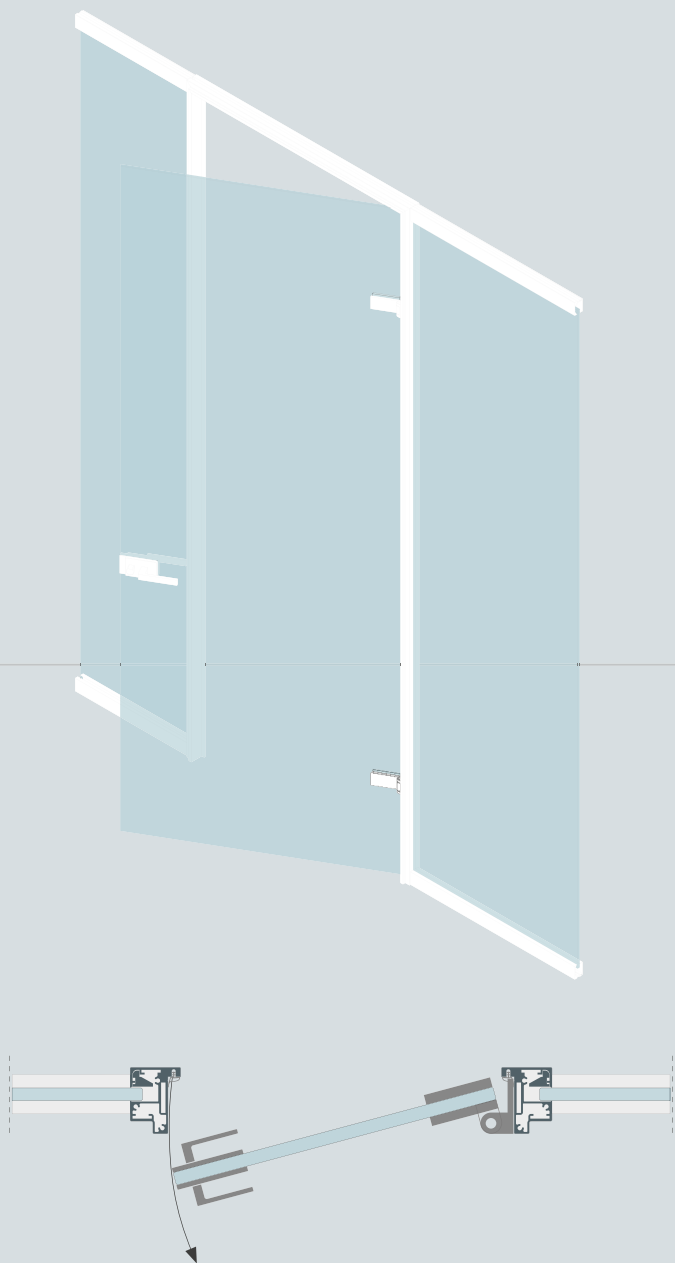

4. Täysslasilevy ilman laatikkoa

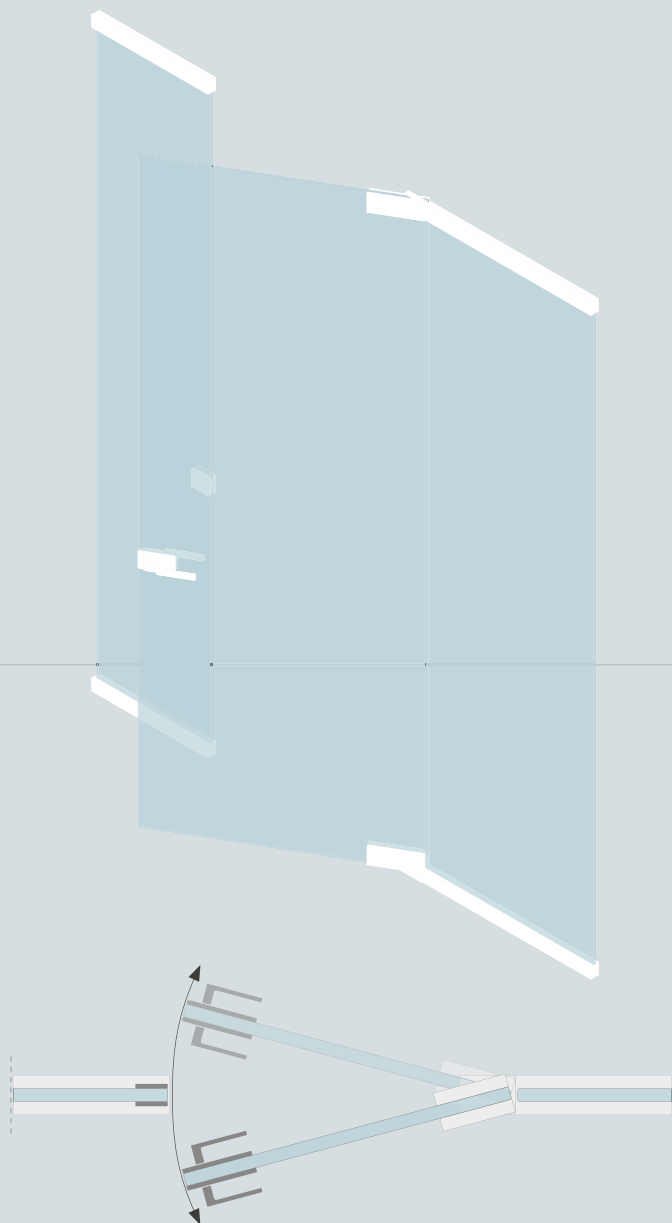

VAIHTOEHDOT LIUKUKANKAISTA VÄLISEINISSÄ



ALUDOORSIN
LEVY/ LIUKUVA

1



ALU2:N LEVY
TANGOILLA / LIUKUVA

2



TÄYSLASILEVY / LIUKUVA

3

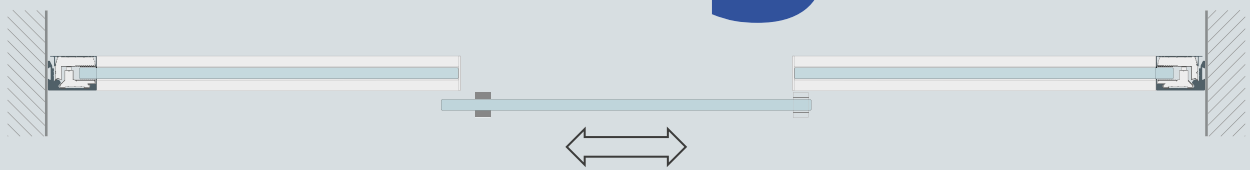

TÄYSLASILEVY / LIUKUVA

4

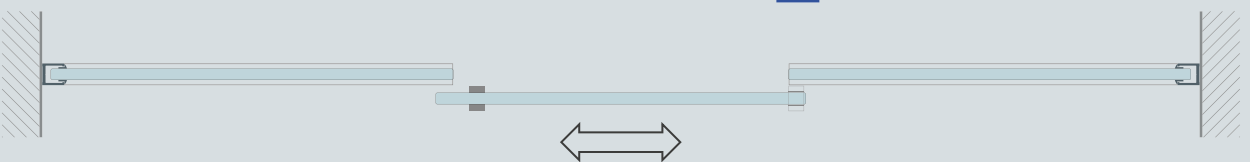

1- Ovilevy alu 1 profilissa

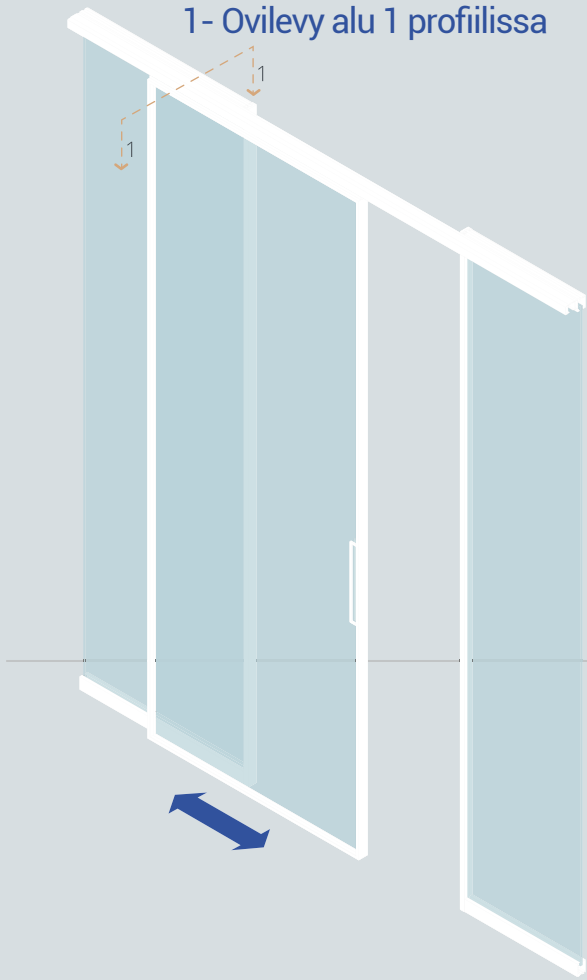

2- Ovilevy Alu 2 -profilissa tangoilla

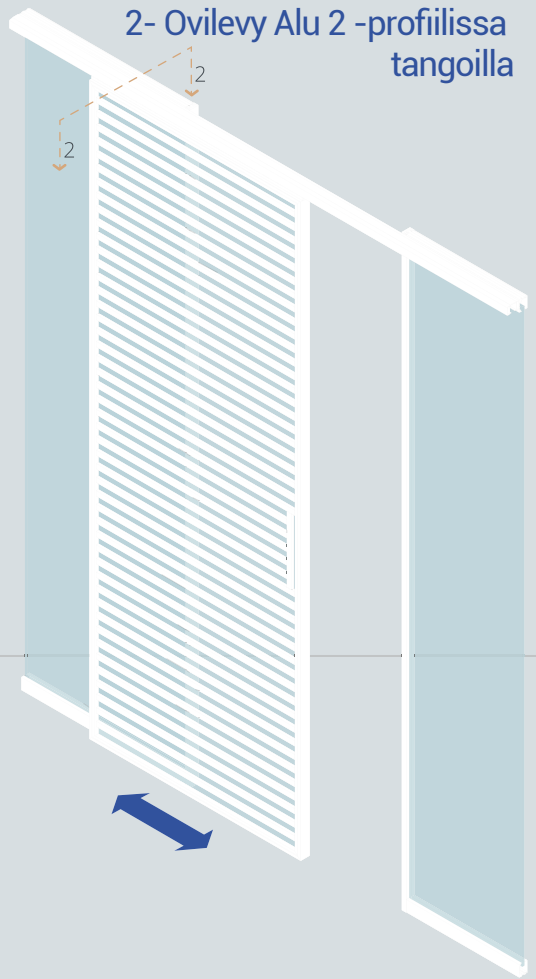

Leikkaus 1-1

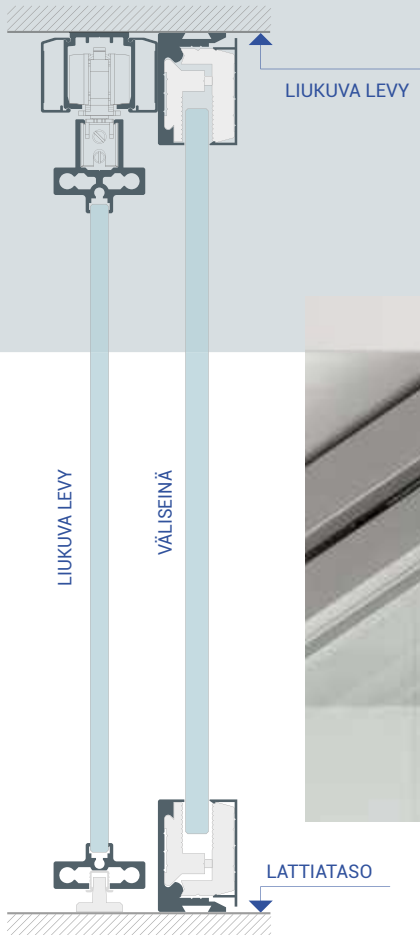

Leikkaus 2-2

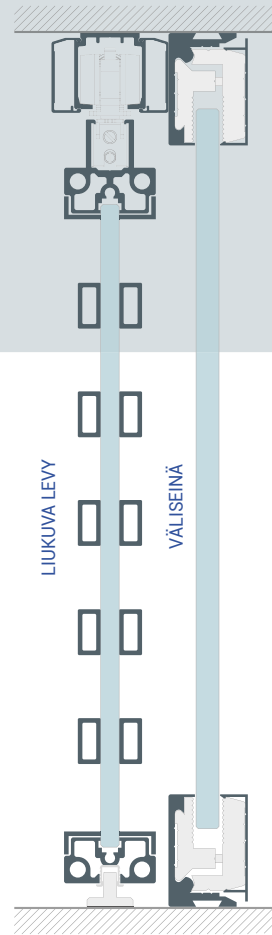

Täytlasilevy järjestelmä L

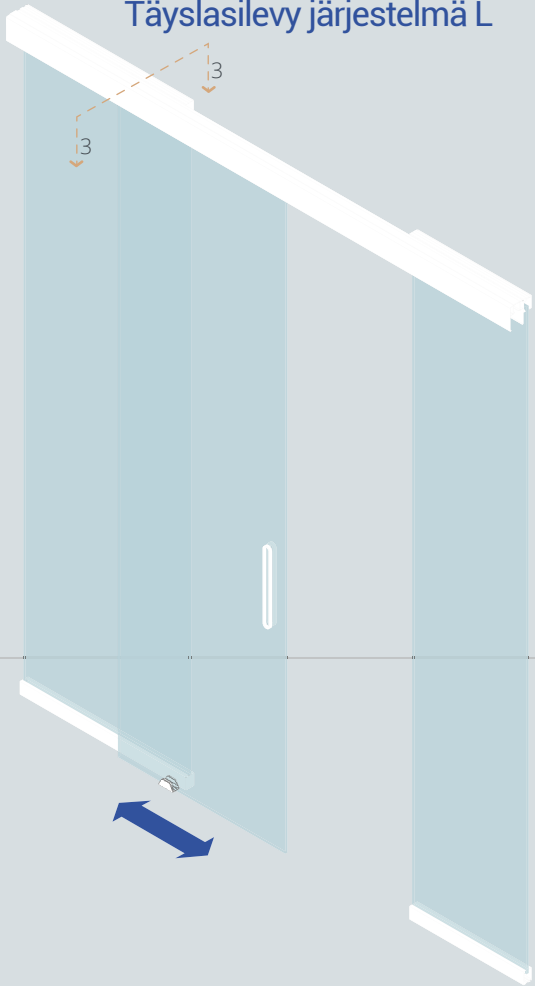

Täytlasilevy järjestelmä F

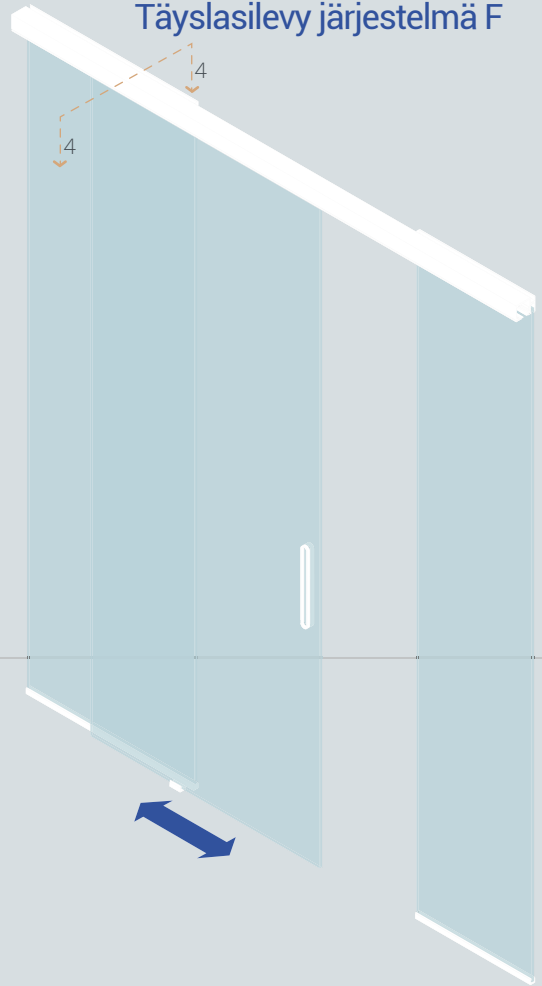

■ Leikkaus 3-3

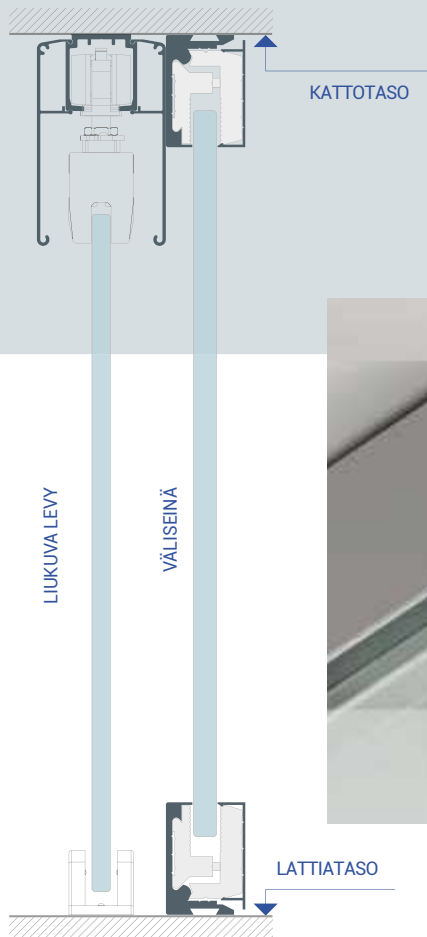

■ Leikkaus 4-4

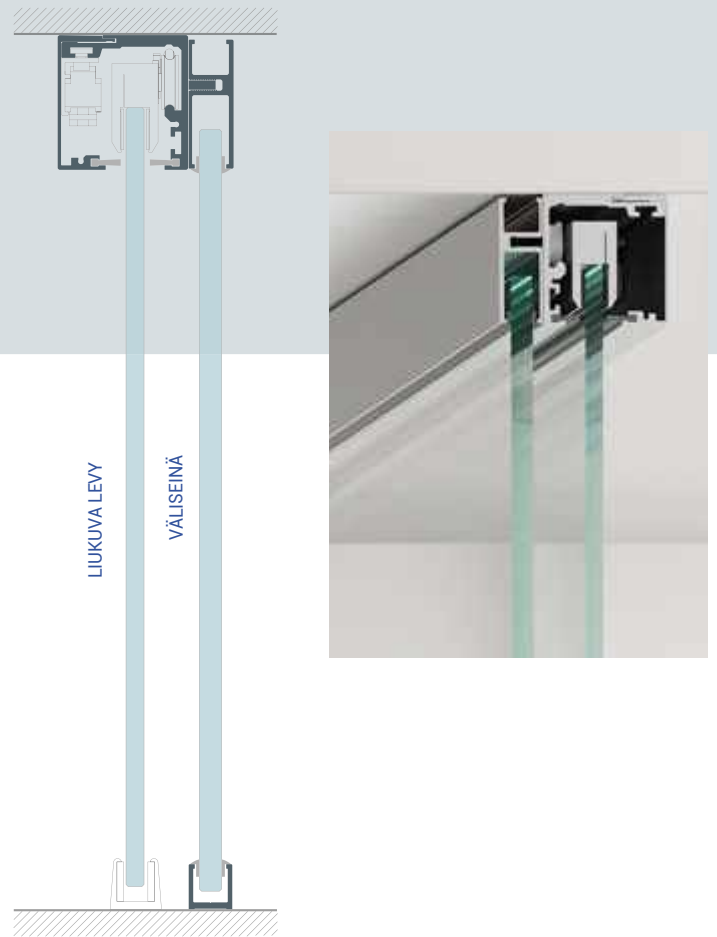



ELOKSOITU



PRONSSI



RUSKEA



VALKOINEN



GRAFIITTI

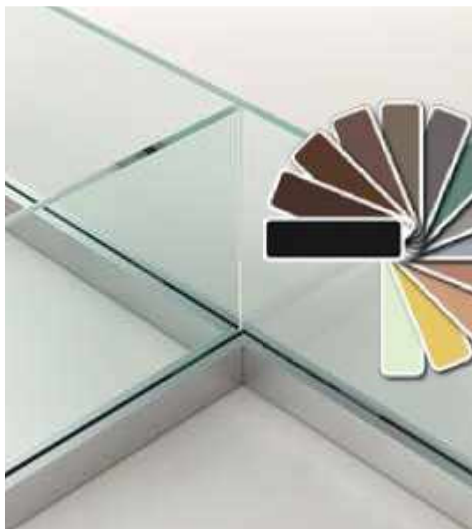

RAL VÄRI



MUSTA

PROFIILIN VÄRI

Lasi läpinäkyvä 6/8/10 mm



TAVALLINEN

TIMANTTI

TAVALLINEN
SATIINI

TIMANTTI
SATIINI

Irtotavarana sävytetty lasi 6/8/10 mm



GRAFIITTI

PRONSSI

GRAFIITTI
SATIINI

PRONSSINEN
SATIINI

Triplex 4+4 mm



TAVALLINEN
«MAITTOINEN»

TIMANTTI
«MAITTOINEN»

TAVALLINEN
«MUSTA»

HOSSET



Yhteystiedot

Myynti

044 744 1465

Sähköposti

myynti@hoset.fi

hoset.fi