

VERUM

ITALY

Verum Italy	02 – 03
Nuda	04 – 09
Maniglie / <i>Handles</i>	16 – 17
Pure	18 – 19
Baar	20 – 21
Lieve	22 – 23
Pepe	24 – 25
Wind	26 – 27
Atlanta	28 – 29
Pomoli / <i>Knobs</i>	30 – 31
Lui	32 – 33
Cham	34 – 35
Soap	36 – 37
Lui Marmo	38 – 39
Nottolini / <i>Privacy sets</i>	40 – 43
Finestre / <i>Windows</i>	44 – 47
Porta blindata / <i>Armoured door</i>	48 – 49
Accessori / <i>Accessories</i>	50 – 59
Ambienti / <i>Environments</i>	60 – 65
Vetro / <i>Glass</i>	66 – 67
Yoyo	68
Tondo	69
Vulcano sliding	70
Cham sliding	71
Piastre porte vetro / <i>Glass door plates</i>	72 – 73
Total Glass	75 – 75
Glass Frame	76 – 77
Vulcano Lock	78 – 79
Finiture / <i>Finishes</i>	80 – 83
Stoppino	84 – 85
Stoppino Open	86 – 93
Stoppino X	94 – 99
Stoppino Close	100 – 105
Profili decorativi / <i>Decorative Profiles</i>	106 – 111
Espositori Commerciali / <i>Commercial display</i>	112 – 115
Condizioni di vendita / <i>Term of sales</i>	116 – 117

VERUM
ITALY

MADE IN ITALY

**When passion
meets research,
when design
meets innovation:
that's where
true italian style
creates efficient
beautiful solutions
for living spaces.**

Verum Italy è un acceleratore di idee, un'azienda in cui innovazione e ricerca si concretizzano per realizzare prodotti unici: soluzioni intelligenti per gli spazi abitativi. Verum Italy opera nel mondo del design per offrire al mercato prodotti inediti e rivoluzionari garantendo estetica e funzionalità. Verum Italy esporta in numerosi Paesi del mondo la qualità tecnica italiana supportata da brevetti a valenza internazionale.

Verum Italy is an ideas accelerator, a company where innovation and research meet to create unique products: smart solutions for living spaces. Verum Italy operates in the design field to offer to the market original and revolutionary products characterised by design and functionality. Verum Italy operates worldwide exporting Italian quality and know-how supported by international patents.

**nu
da.**

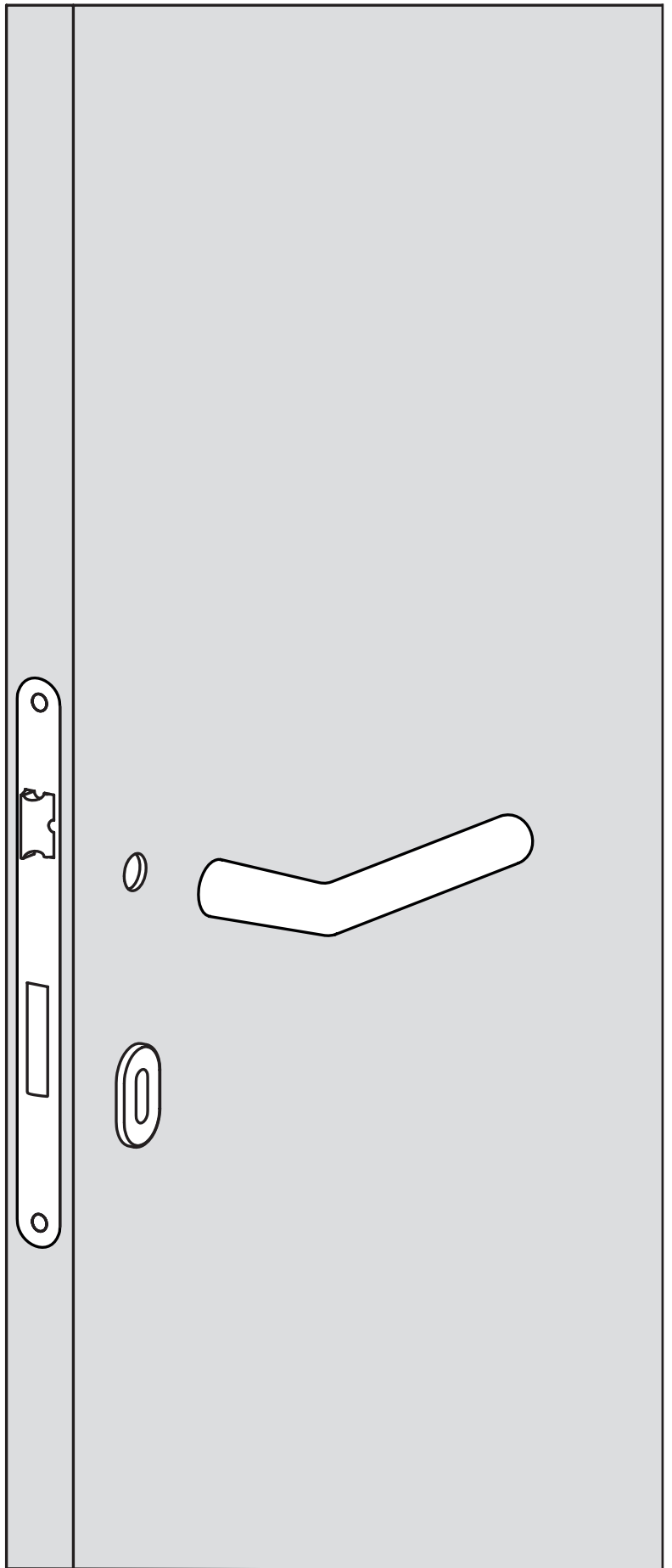
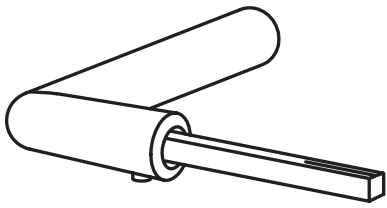

Sistema brevettato
Patented system

**L'unica maniglia
senza rosetta**

**The only handle
without the rose**

Nuda è una collezione di maniglie che utilizza un innovativo sistema brevettato che ne permette il fissaggio senza rosetta, perfetto per un design minimalista. Il montaggio avviene in pochi secondi senza necessitare di competenze tecniche o attrezzature specifiche. Nuda è adattabile a ogni spessore e tipologia di porta. Le sue funzionalità sono garantite secondo DIN 1906.

Nuda is a collection of handles with an innovative patented system whose assembly does not require anymore the rose.

A minimalist and design solution for any door. The assembly is very quick, it can be done in few seconds and it does not require any specific technical skills and tools. Nuda can be adapted to any thickness and typology of door. The functionality of Nuda is guaranteed by DIN 1906.

**Less is more,
Nuda is magic**

Fissaggio senza viti nel pannello porta

**Assemblaggio rapido stringendo due grani,
disponibile anche versione a un grano**

**Adattabile a diversi fori con diametri da
16 a 30 mm / 0,63 – 1,18 inch**

Sistema brevettato testato oltre 200.000 cicli

Cuscinetto a sfera testato oltre 1.000.000 cicli

**Disponibili accessori coordinati per finestre
e porte blindate**

Prodotto in Italia

Fixing without screws in the door panel

**Fast assembly screwing two grains
(one grain version available as well)**

**Suitable for different holes diameter,
from 16 mm to 30 mm / 0,63 – 1,18 inch**

**Patented system tested over 200.000 cycles
according to European locks standards**

Ball bearing tested over 1.000.0000 cycles

**Coordinated accessories for windows
and armoured doors available**

Made in Italy



Maniglia Atlanta
Atlanta Handle



Maniglia Pure
Pure Handle



Maniglia Wind
Wind Handle

Pomolo Soap
Soap Knob

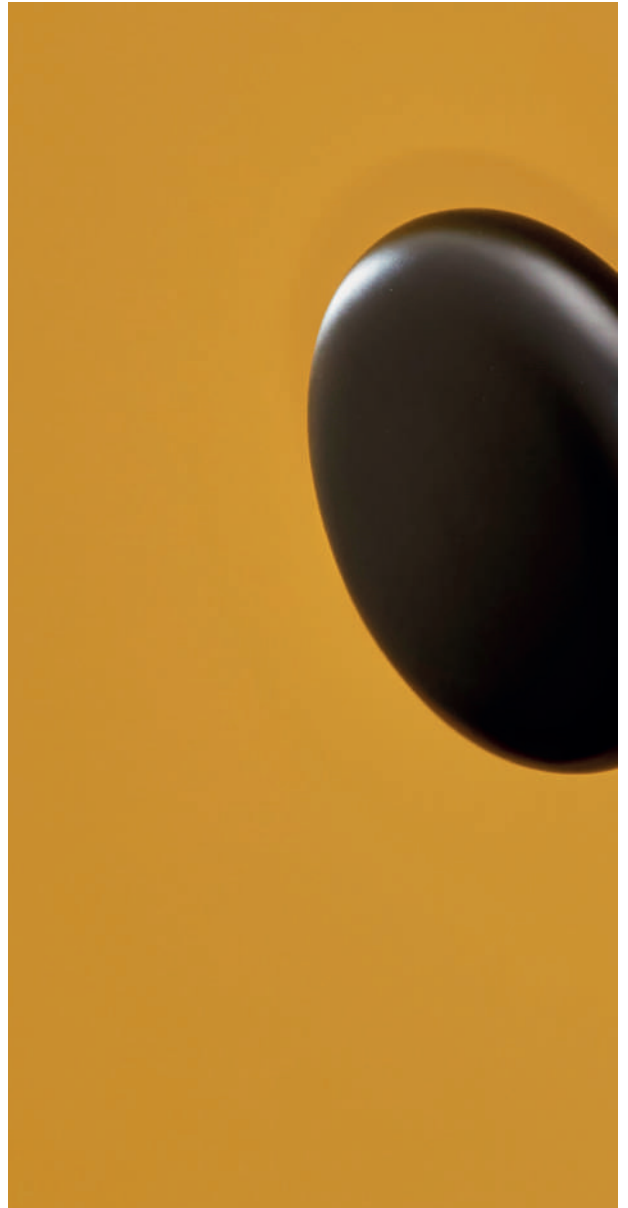



Pomolo Lui
Lui Knob

Maniglia Pepe
Pepe Handle



Maniglie

Handles



Pure

18



Baar

20



Lieve

22



Pepe

24



Wind

26



Atlanta

28

Cod. 127001



Bronzo Yester
Yester Bronze

mm
inch

Finiture / Finishes

- cod. 14 Cromo Satinato / *Satin Chrome*
- cod. 39 Cromo Lucido / *Polished Chrome*
- cod.18 Nero Etna / *Etna Black*
- cod. 49 Bianco Monviso / *Monviso White*
- cod.21 Bronzo Yester / *Yester Bronze*

Porta / Door

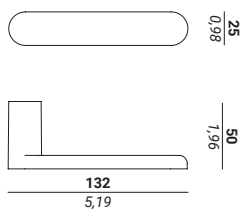

Quadro / Spindle ☑ 8 / 0,31

Finestra / Window

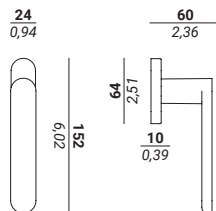

Bocchetta / Escutcheon

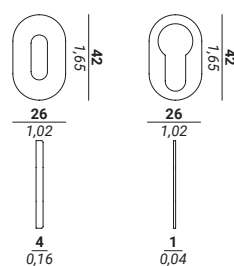



Cromo Satinato
Satin Chrome

Cod. 127006

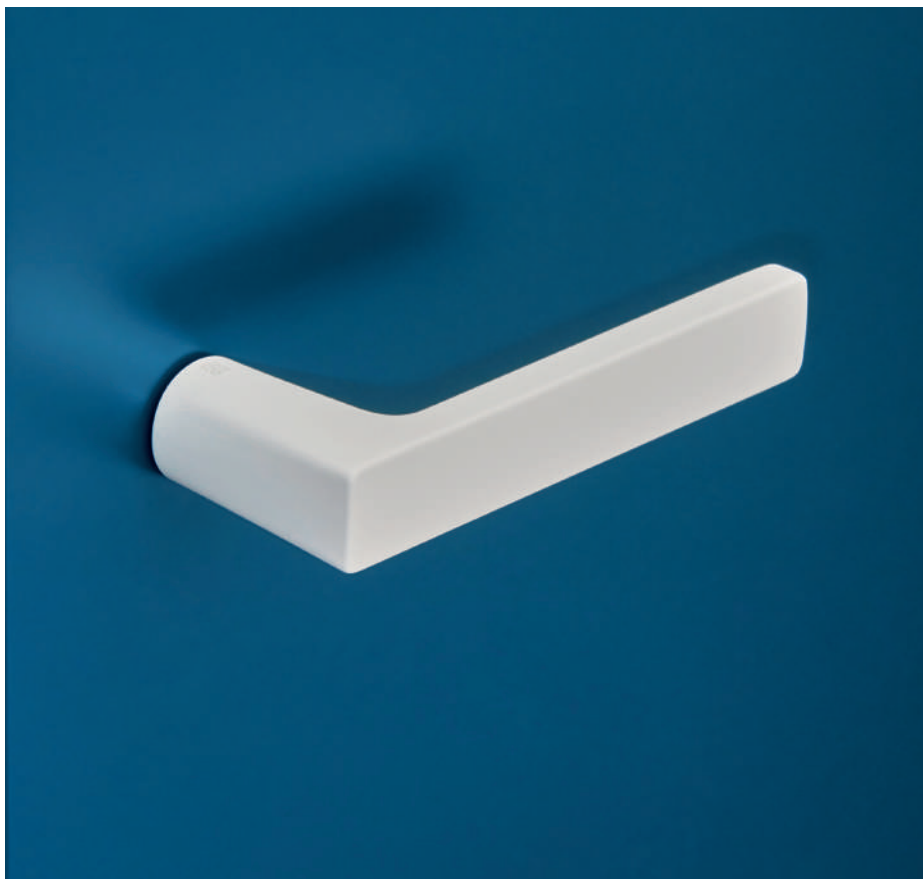

Bianco Monviso
Monviso White

mm
inch

Finiture / Finishes

- cod. 14 Cromo Satinato / *Satin Chrome*
- cod. 39 Cromo Lucido / *Polished Chrome*
- cod. 18 Nero Etna / *Etna Black*
- cod. 49 Bianco Monviso / *Monviso White*
- cod. 21 Bronzo Yester / *Yester Bronze*

Porta / Door

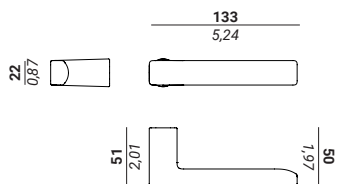

Finestra / Window

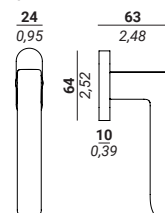

Bocchetta / Escutcheon

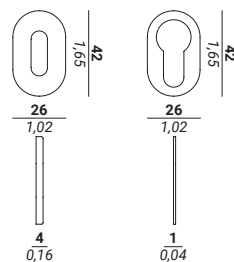

Quadro / Spindle ☑ 8 / 0,31



Nero Etna
Etna Black

Cod. 127005



Cromo Satinato
Satin Chrome

mm
inch

Finiture / Finishes

- cod. 14 Cromo Satinato / *Satin Chrome*
- cod. 39 Cromo Lucido / *Polished Chrome*
- cod. 18 Nero Etna / *Etna Black*
- cod. 49 Bianco Monviso / *Monviso White*
- cod. 21 Bronzo Yester / *Yester Bronze*

Porta / Door

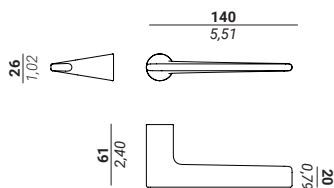

Finestra / Window

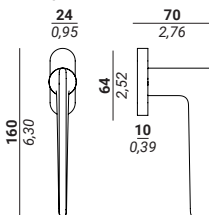

Bocchetta / Escutcheon

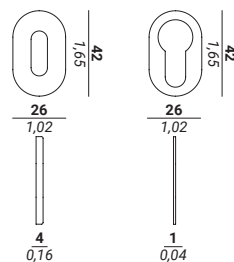

Quadro / Spindle ☑ 8 / 0,31



Nero Etna
Etna Black

Pepe

Design:
Alessandro Stabile

Cod. 127007



Cromo Lucido
Polished Chrome

mm
inch

Finiture / Finishes

- cod. 14 **Cromo Satinato / Satin Chrome**
- cod. 39 **Cromo Lucido / Polished Chrome**
- cod.18 **Nero Etna / Etna Black**
- cod. 49 **Bianco Monviso / Monviso White**
- cod.21 **Bronzo Yester / Yester Bronze**

Maniglia / Handle

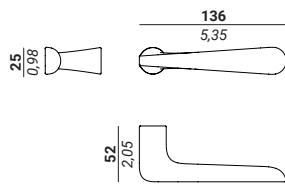

Finestra / Window

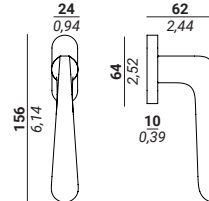

Bocchetta / Escutcheon

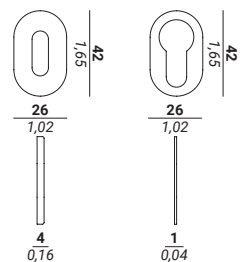

Quadro / Spindle ☑ 8 / 0,31

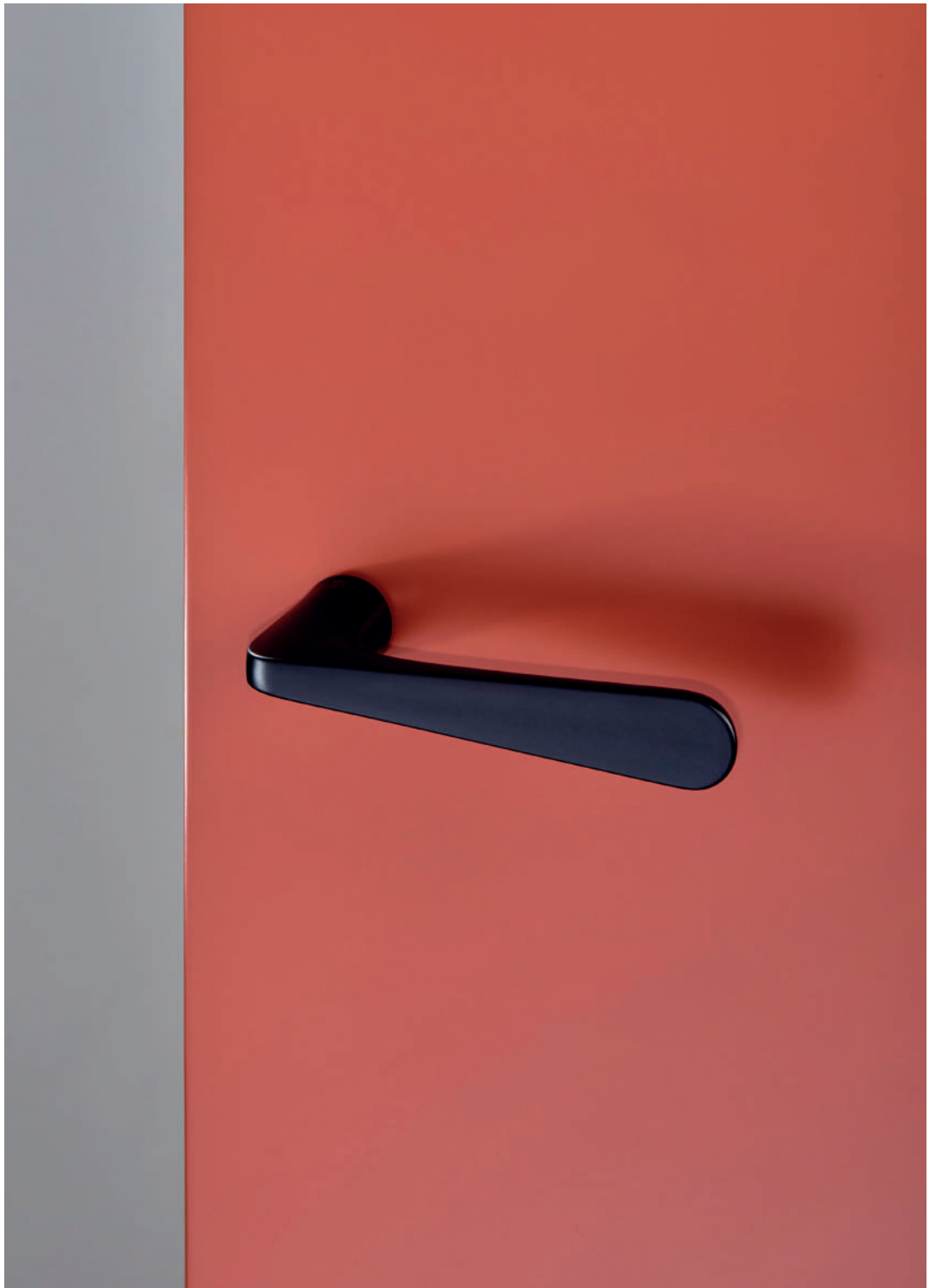

Nero Etna
Etna Black

Wind

Design:
Mattia Ferremi

Cod. 127002



Nero Etna
Etna Black

mm
inch

Finiture / Finishes

- cod. 14 Cromo Satinato / *Satin Chrome*
- cod. 39 Cromo Lucido / *Polished Chrome*
- cod.18 Nero Etna / *Etna Black*
- cod. 49 Bianco Monviso / *Monviso White*
- cod.21 Bronzo Yester / *Yester Bronze*

Maniglia / Handle

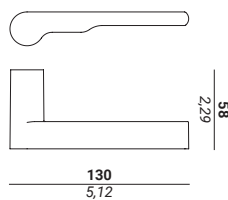

Quadro / Spindle 8 / 0,31

Finestra / Window

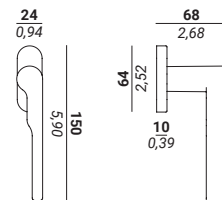

Bocchetta / Escutcheon

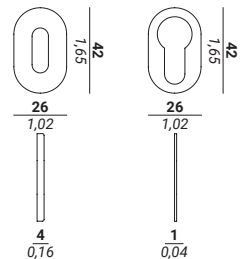



Bianco Monviso
Monviso White

Cod. 127003



Nero Etna
Etna Black

mm
inch

Finiture / Finishes

- cod. 14 Cromo Satinato /
Satin Chrome
- cod. 39 Cromo Lucido /
Polished Chrome
- cod.18 Nero Etna /
Etna Black
- cod. 49 Bianco Monviso /
Monviso White
- cod.21 Bronzo Yester /
Yester Bronze

Maniglia / Handle

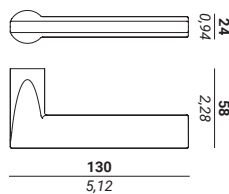

Quadro / Spindle 8 / 0,31

Finestra / Window

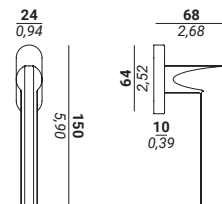

Bocchetta / Escutcheon

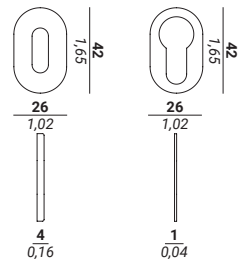



Cromo Lucido
Polished Chrome

Pomoli

Knobs



Lui

32



Cham

34



Soap

36

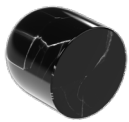

Lui Marmo

38

Cod. 127004

Set pomoli girevoli / Turnable knob set

$\frac{\text{mm}}{\text{inch}}$

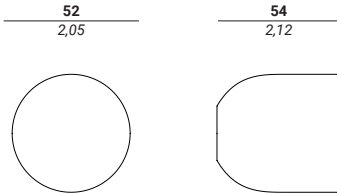

Quadro / Spindle 8 / 0,31

Disponibili anche / Also available

Set pomolo fisso singolo / Single fixed knob set

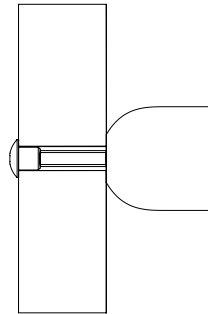

Set pomolo singolo fisso fissaggio frontale / Single fixed knob set frontal fixing

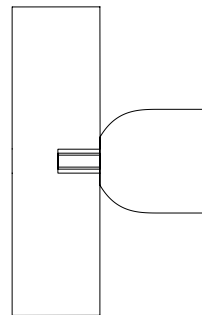

Set pomolo fisso doppio / Double fixed knob set

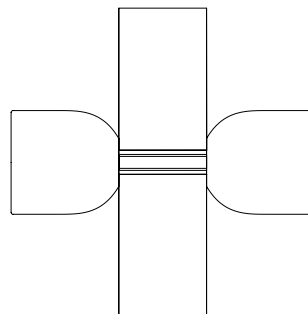

Bocchetta / Escutcheon

$\frac{\text{mm}}{\text{inch}}$

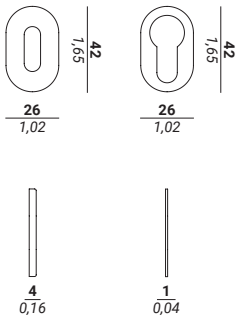

Finiture per alluminio / Finishes for aluminium

- cod. 80 Grigio Milano / Milan Grey
- cod. 18 Nero Etna / Etna Black
- cod. 49 Bianco Monviso / Monviso White

Finiture per ottone / Finishes for brass

- cod. 14 Cromo Satinato / Satin Chrome
- cod. 21 Bronzo Yester / Yester Bronze
- cod. 37 Ottone Lucido / Polished Brass



Grigio Milano
Milan Grey

Cham

Design:
Nuda R&D

Cod. 127008

Set pomoli girevoli / Turnable knob set

$\frac{\text{mm}}{\text{inch}}$

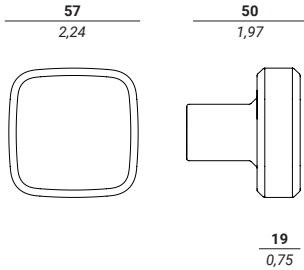

Quadro / Spindle 8 / 0,31

Bocchetta / Escutcheon

$\frac{\text{mm}}{\text{inch}}$

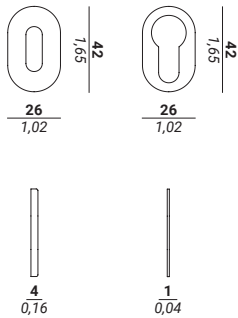

Finiture per alluminio /
Finishes for aluminium

- cod. 80 Grigio Milano /
Milan Grey
- cod. 18 Nero Etna /
Etna Black
- cod. 49 Bianco Monviso /
Monviso White

Finiture per ottone /
Finishes for brass

- cod. 14 Cromo Satinato /
Satin Chrome
- cod. 21 Bronzo Yester /
Yester Bronze
- cod. 37 Ottone Lucido /
Polished Brass

Disponibili anche / Also available

Set pomolo fisso singolo / Single fixed knob set

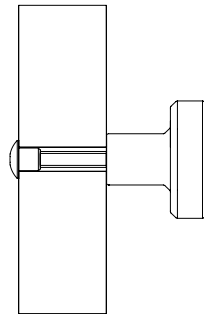

Set pomolo singolo fisso fissaggio frontale / Single fixed knob set frontal fixing

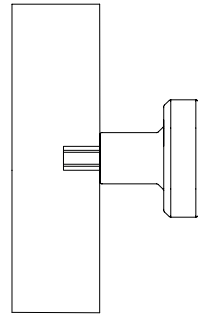

Set pomolo fisso doppio / Double fixed knob set

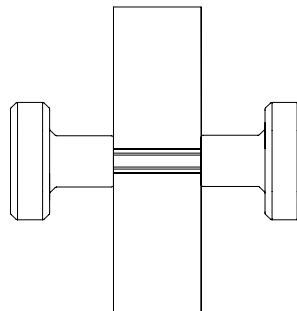



Bianco Monviso
Monviso White

Soap

Design:
Nuda R&D

Cod. 127009

Set pomoli girevoli / Turnable knob set

$\frac{\text{mm}}{\text{inch}}$

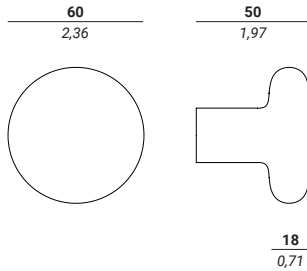

Quadro / Spindle 8 / 0,31

Bocchetta / Escutcheon

$\frac{\text{mm}}{\text{inch}}$

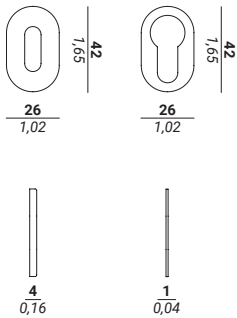

Finiture per alluminio / Finishes for aluminium

- cod. 80 Grigio Milano /
Milan Grey
- cod. 18 Nero Etna /
Etna Black
- cod. 49 Bianco Monviso /
Monviso White

Finiture per ottone / Finishes for brass

- cod. 14 Cromo Satinato /
Satin Chrome
- cod. 21 Bronzo Yester /
Yester Bronze
- cod. 37 Ottone Lucido /
Polished Brass

Disponibili anche / Also available

Set pomolo fisso singolo / Single fixed knob set

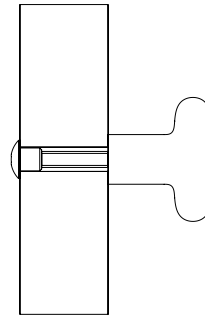

Set pomolo singolo fisso fissaggio frontale / Single fixed knob set frontal fixing

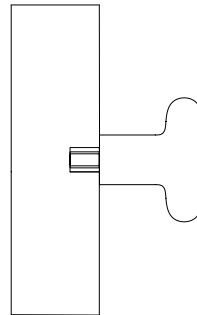

Set pomolo fisso doppio / Double fixed knob set

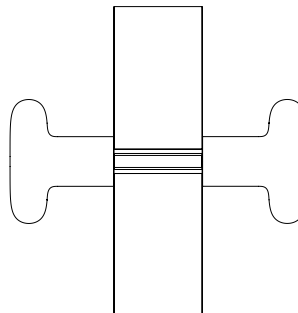



Nero Etna
Etna Black

Lui Marmo

Design:
Alessandro Stabile

Cod. 127010

Set pomoli girevoli / Turnable knob set

$\frac{\text{mm}}{\text{inch}}$

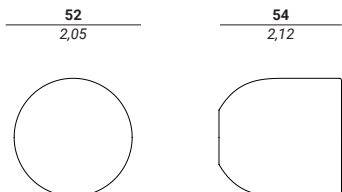

Quadro / Spindle 8 / 0,31

Bocchetta / Escutcheon

$\frac{\text{mm}}{\text{inch}}$

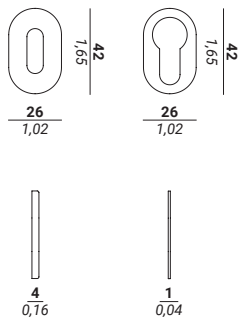

Per progetti speciali è possibile realizzare il modello Lui Marmo in marmo bianco Carrara lucido e marmo nero Marquinia lucido.

For special projects, it is possible to provide model Lui Marmo in polished white Carrara marble and polished black Marquinia marble.

Disponibili anche / Also available

Set pomolo fisso singolo / Single fixed knob set

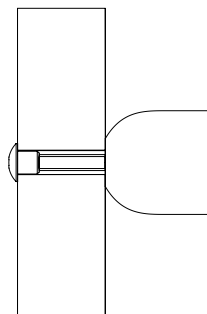

Set pomolo singolo fisso fissaggio frontale / Single fixed knob set frontal fixing

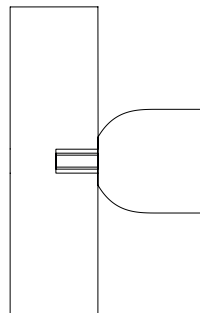

Set pomolo fisso doppio / Double fixed knob set

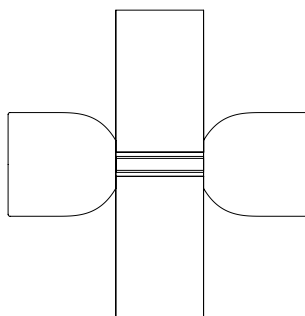



Nottolini

Privacy sets

Nuda offre dei nottilini dedicati da abbinare al design delle proprie maniglie per avere una continuità di immagine. Il nottilino diviene elemento tecnico, funzionale ed estetico al contempo.



Nuda offers privacy sets to be specifically matched to the design of the handle and have a continuity in terms of image. The privacy set becomes a technical, functional and aesthetic element at the same time.

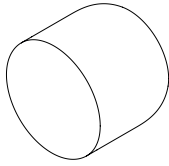

$\frac{27}{1,06}$

$\frac{23}{0,90}$

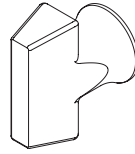
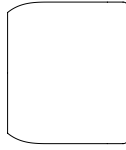
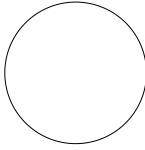

$\frac{14}{0,55}$

$\frac{33}{1,30}$

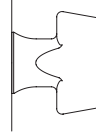
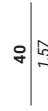
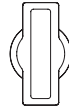

$\frac{\text{mm}}{\text{inch}}$



Nottolino Punto può essere abbinato a tutte le maniglie e pomoli Nuda
Punto privacy set can be easily combined to every Nuda handle and knob

Spessore pannello tra 40 e 55 mm (1,57 e 2,16 inch)
Panel thickness 40 and 55 mm (1,57 and 2,16 inch)

Foro richiesto 16 mm / 0,62 inch
Required hole 16 mm / 0,62 inch

Quadro / Spindle 6 mm / 0,24 inch
 Cod. 128015



Nottolino per maniglia Atlanta
Privacy set for Atlanta handle

Spessore pannello tra 40 e 55 mm (1,57 e 2,16 inch)
Panel thickness 40 and 55 mm (1,57 and 2,16 inch)

Foro richiesto 20 mm / 0,79 inch
Required hole 20 mm / 0,79 inch

Quadro / Spindle 6 mm / 0,24 inch
 Cod. 128007

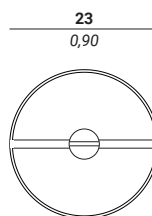
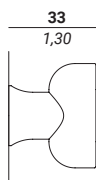
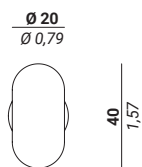
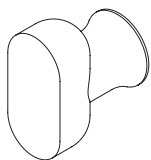

Nottolino per maniglia Pure e Wind
Privacy set for Pure and Wind handle

Spessore pannello tra 40 e 55 mm (1,57 e 2,16 inch)
Panel thickness 40 and 55 mm (1,57 and 2,16 inch)

Foro richiesto 20 mm / 0,79 inch
Required hole 20 mm / 0,79 inch

Quadro / Spindle 6 mm / 0,24 inch
 Cod. 128006



Lato esterno nottolino Punto
External side Punto privacy set

Finiture / Finishes

- cod. 14 Cromo Satinato / *Satin Chrome*
- cod. 39 Cromo Lucido / *Polished Chrome*
- cod. 49 Bianco Monviso / *Monviso White*
- cod. 18 Nero Etna / *Etna Black*
- cod. 21 Bronzo Yester / *Yester Bronze*
- cod. 80 Grigio Milano / *Milan Grey*

Finestre

Windows

Nuda offre una soluzione di estremo minimalismo anche per la finestra. La maniglia diviene così elemento di sintesi tra porta e finestra.



Nuda offers a solution of extreme minimalism also for the window. The handle becomes a perfect cohesion element between the door and the window.

Slim 4 movimenti / Slim 4 movements

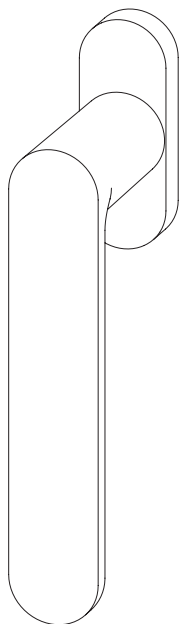

Pure
Cod. 129001

Wind
Cod. 129002

Atlanta
Cod. 129003

Lieve
Cod. 129005

Baar
Cod. 129006

Pepe
Cod. 129007

Standard 4 movimenti / Standard 4 movements

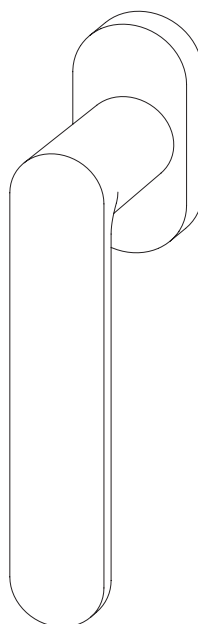

Pure
Cod. 129201

Wind
Cod. 129202

Atlanta
Cod. 129203

Lieve
Cod. 129205

Baar
Cod. 129206

Pepe
Cod. 129207

24
0,94

mm
inch

30
1,18



152
5,98

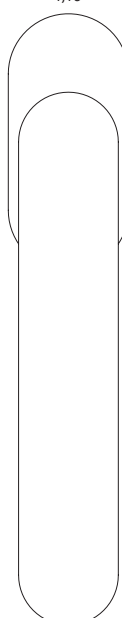

152
5,98

Finiture / Finishes

cod. 14 Cromo Satinato / *Satin Chrome*
 cod. 39 Cromo Lucido / *Polished Chrome*
 cod. 49 Bianco Monviso / *Monviso White*
 cod.18 Nero Etna / *Etna Black*
 cod. 21 Bronzo Yester / *Yester Bronze*
 cod. 80 Grigio Milano / *Milan Grey*

Maniglioni alzanti scorrevoli / Lift slide handles

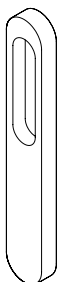
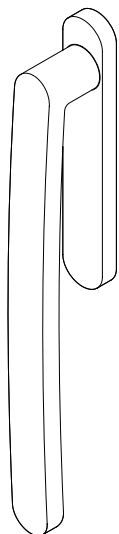

Round

Cod. 12501401
Versione maniglione con nicchia /
Lift slide handle with niche version

Cod. 12501402
Versione doppio maniglione foro cilindro /
Double lift slide handle cylinder hole version

Quadro / Spindle 10 mm / 0,39 inch

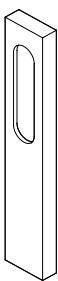
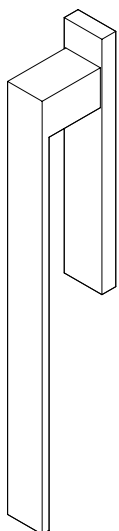
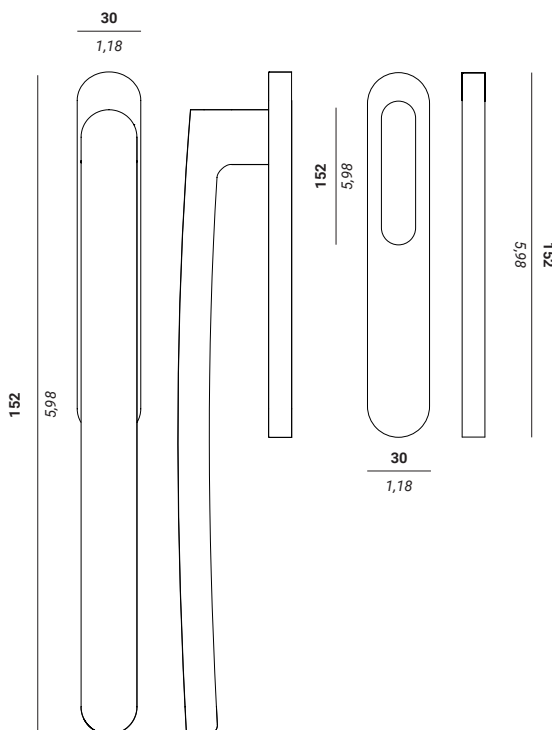

Square

Cod. 12501501
Versione maniglione con nicchia /
Lift slide handle with niche version

Cod. 12501502
Versione doppio maniglione foro cilindro /
Double lift slide handle cylinder hole version

Quadro / Spindle 10 mm / 0,39 inch

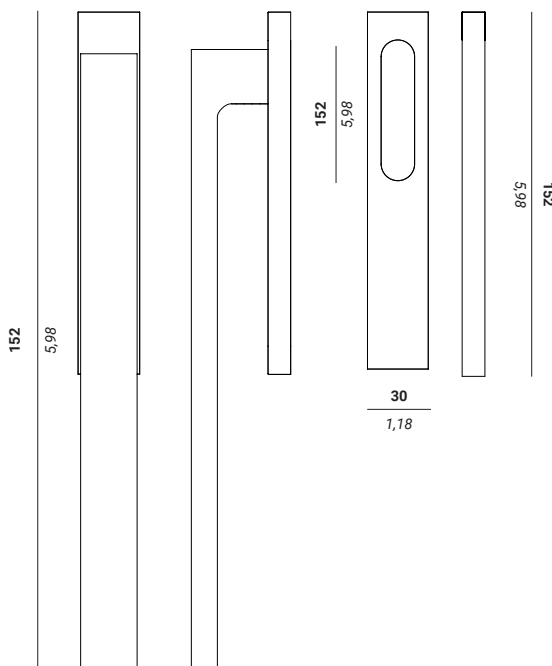

Porta blindata

Armoured door

Kit mezza maniglia per porta blindata / *Half handle kit for armoured door*

Cod. 130

Kit mezza maniglia con rondella e quadro ad espansione per porta blindata
Half handle kit with washer and expansion-knurled spindle for armoured door



Finiture / Finishes

- cod. 14 Cromo Satinato /
Satin Chrome
- cod. 39 Cromo Lucido /
Polished Chrome
- cod. 18 Nero Etna /
Etna Black
- cod. 49 Bianco Monviso /
Monviso White
- cod. 21 Bronzo Yester /
Yester Bronze

Materiale / Material

Zama / Zamak

Kit mezza maniglia per porta blindata con rondella 30 mm / 1,18 inch
premontata e quadro a espansione 8 mm / 0,31 inch di lunghezza 85 mm /
3,35 inch

*Half handle kit for armoured door with 30 mm / 1,18 inch washer and
expansion-knurled 8 mm / 0,31 inch spindle of 85 mm / 3,35 inch length.*

Accessori

Accessories

La collezione Nuda include un'ampia gamma di accessori per poter soddisfare le esigenze tecniche per ogni tipologia porta.



Nuda collection includes a wide range of accessories to meet all technical needs for every door.

Bocchette e rondelle/ Escutcheons and washers

mm
inch

A. Bocchetta Slim / Slim escutcheon

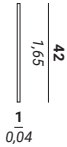

Foro chiave / Key hole
Cod. 128002



Foro cilindro / Cylinder hole
Cod. 128005

B. Bocchetta Standard / Standard escutcheon

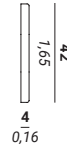

Foro chiave / Key hole
Cod. 128001



Foro cilindro / Cylinder hole
Cod. 128004

C. Bocchetta Slim diametro 30 mm - 1,18 inch per foro chiave / Slim key hole escutcheon diameter 30 mm - 1,18 inch

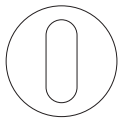

Ø 30
Ø 1,18



1
0,04

Da abbinare a rondella
diametro 30 mm / 1,18 inch
Cod. 128009
To be matched with 30 mm /
1,18 inch diameter washer
Cod. 128009

Cod. 128010

D. Bocchetta Slim diametro 45 mm - 1,77 inch per foro chiave / Slim key hole escutcheon diameter 45 mm - 1,77 inch

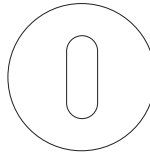

Ø 45
Ø 1,77



1
0,04

Da abbinare a rondella
diametro 45 mm / 1,77 inch
Cod. 128025
To be matched with 45 mm /
1,77 inch diameter washer
Cod. 128025

Cod. 128026

E. Bocchetta Slim diametro 45 mm - 1,77 inch per foro cilindro / Slim cylinder hole escutcheon diameter 45 mm - 1,77 inch

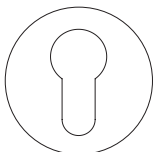

Ø 45
Ø 1,77



1
0,04

Da abbinare a rondella
diametro 45 mm / 1,77 inch
Cod. 128025
To be matched with 45 mm /
1,77 inch diameter washer
Cod. 128025

Cod. 128027

F. Rondella diametro 30 mm - 1,18 inch per nottolino modello Pure, Wind e Atlanta / 30 mm - 1,18 inch diameter washer for privacy set model Pure, Wind and Atlanta

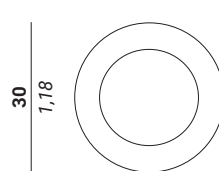

30
1,18

Cod. 128029

Bocchette e rondelle/ Escutcheons and washers

mm
inch

G. Rondella diametro 24 mm - 0,94 inch / 24 mm - 0,94 inch diameter washer

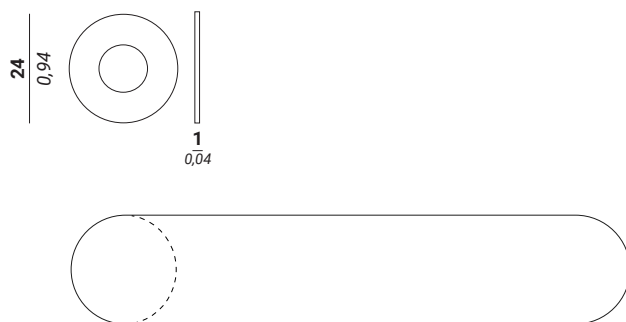

Per pannelli preforati con
diametro fino a 20 mm / 0,94 inch
For predrilled panels with a
diameter up to 20 mm / 0,94 inch

Disponibile nelle finiture come le maniglie
Available in the same handle finishes

Cod. 128008

H. Rondella diametro 30 mm - 1,18 inch / 30 mm - 1,18 inch diameter washer

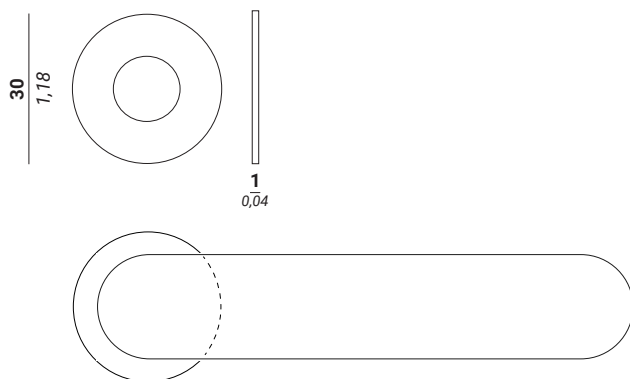

Per pannelli preforati con
diametro fino a 24 mm / 0,94 inch fuori asse
For predrilled panels with a
diameter up to 24 mm / 0,94 inch out of axis

Disponibile nelle finiture come le maniglie
Available in the same handle finishes

Cod. 128009

I. Rondella diametro 45 mm - 1,77 inch / 45 mm - 1,77 inch diameter washer

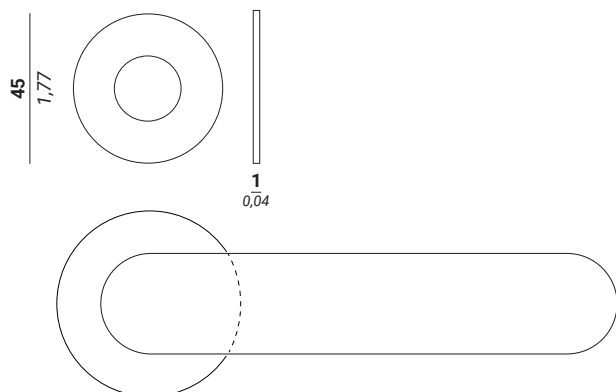

Per pannelli preforati con
diametro fino a 30 mm / 1,18 inch
For predrilled panels with a
diameter up to 30 mm / 1,18 inch

Disponibile nelle finiture come le maniglie
Available in the same handle finishes

Cod. 128025

Maniglia ad incasso per scorrevoli in legno / Inset handles for sliding wooden doors

Finiture / Finishes

- cod. 14 Cromo Satinato / *Satin Chrome*
- cod. 39 Cromo Lucido / *Polished Chrome*
- cod. 49 Bianco Monviso / *Monviso White*
- cod.18 Nero Etna / *Etna Black*
- cod. 21 Bronzo Yester / *Yester Bronze*
- cod. 37 Ottonato Lucido / *Polished brass*

Maniglia ad incasso per scorrevole con nottolino e ditale Inset thumb turn handle with recessed finger pull Cod. 122015

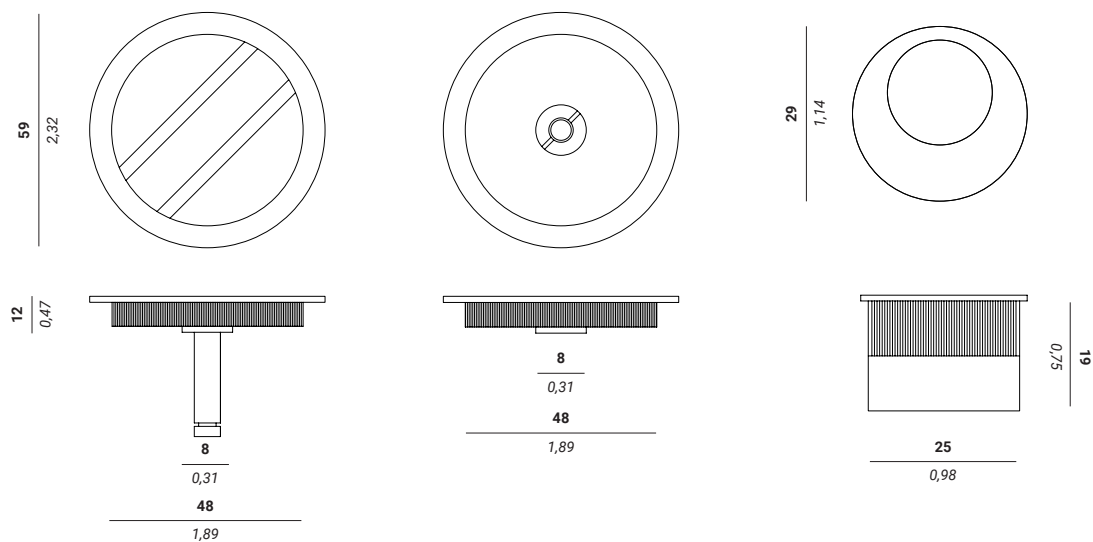

Maniglia ad incasso per scorrevole con nottolino Inset thumb turn handle Cod. 122013

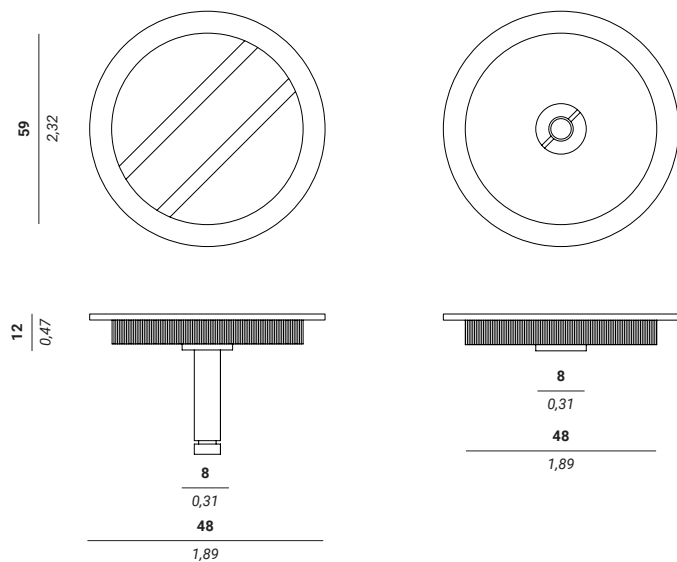

Maniglie ad incasso per scorrevoli in legno / *Inset handles for sliding wooden doors*

Finiture / Finishes

cod. 14 Cromo Satinato / *Satin Chrome*
cod. 39 Cromo Lucido / *Polished Chrome*
cod. 49 Bianco Monviso / *Monviso White*
cod.18 Nero Etna / *Etna Black*
cod. 21 Bronzo Yester / *Yester Bronze*
cod. 37 Ottonato Lucido / *Polished brass*

Maniglia ad incasso cieca

Inset handle

Cod. 122016

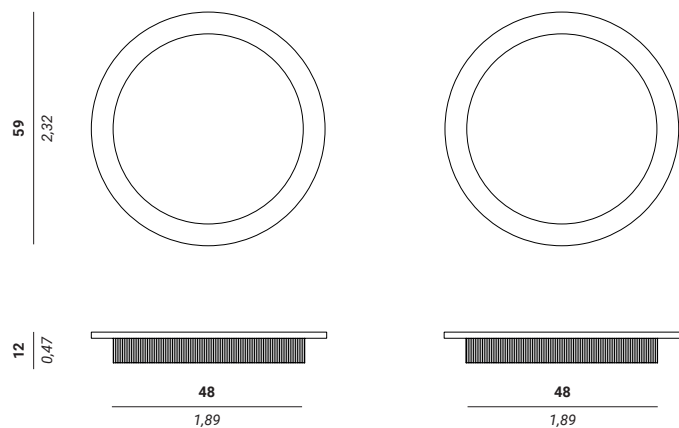

Maniglia ad incasso cieca

Inset handle with recessed finger pull

Cod. 122017

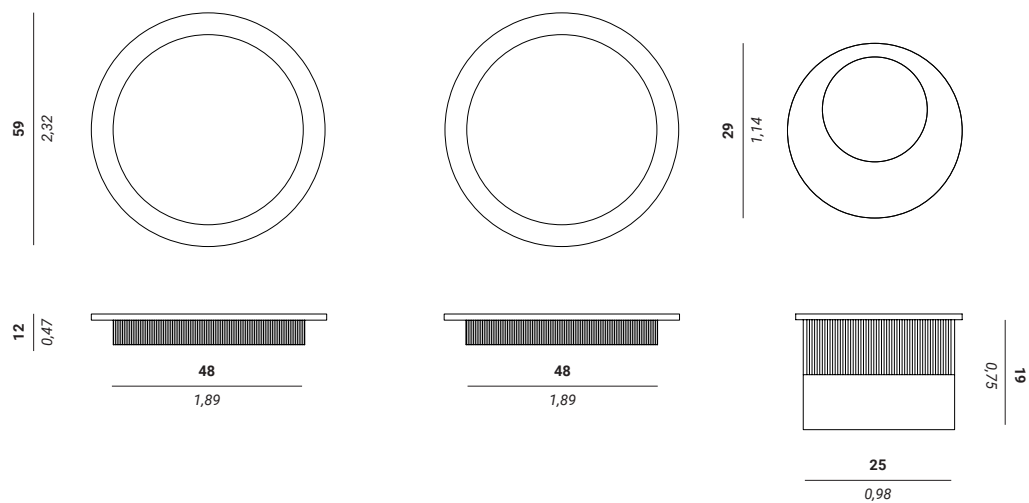

Serrature / Locks

Incontri / Striking plates

Serrature magnetiche/ *Magnetic locks*
Cod. 180

Serrature meccaniche / *Mechanical locks*
Cod. 183

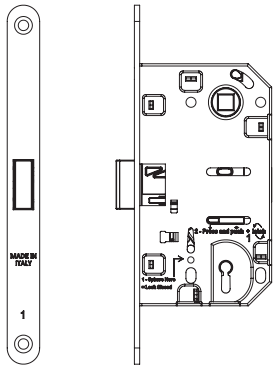

Foro chiave /
Keyhole

Cod. 004

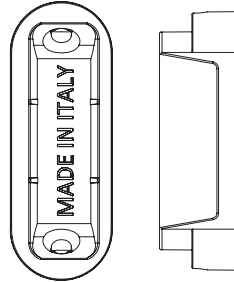

Incontro per serratura magnetica /
Striking plate for magnetic lock
Cod. 181001

Incontro per serratura meccanica /
Striking plate for mechanical lock

Cod. 184005

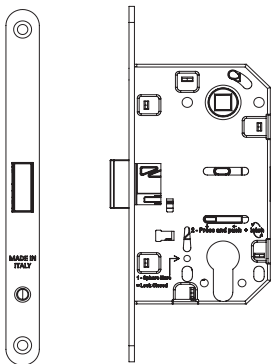

Foro cilindro /
Cylinder hole

Cod. 005

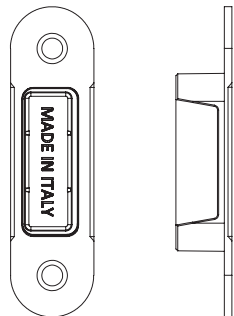

Incontro con piastrina per
serratura magnetica /
*Striking plate with platelet for
magnetic lock*
Cod. 181003

Incontro con piastrina per
serratura meccanica /
*Striking plate with platelet for
mechanical lock*
Cod. 184004

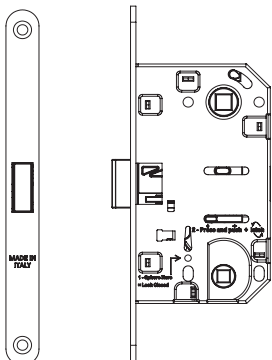

Foro nottolino /
Privacy set hole

Cod. 006

Finiture / *Finishes*

Cromo Satinato / *Satin Chrome*
Cromo Lucido / *Polished Chrome*
Bianco Monviso / *Monviso White*
Nero Etna / *Etna Black*
Bronzo Yester / *Yester Bronze*

Materiale / *Material*

Abs / *Abs*
Metallo / *Metal*

Quadri per maniglie / *Handles spindles*

Le maniglie della collezione Nuda vengono fornite con un quadro con fissaggio a due grani per porte di spessore compreso tra i 40 e 60 mm / 1,57 e 2,36 inch.

Su richiesta è possibile fornire quadri adatti per i seguenti spessori:

30-50 mm / 1,18- 1,97 inch
50-70 mm / 1,97 – 2,76 inch
60-80 mm / 2,36 – 3,15 inch

Per il mondo dell'industria, è possibile richiedere un quadro premontato di lunghezza desiderata con fissaggio a un solo grano.

Nuda handles come as standard with a spindle with 2 fixing grains for 40-60 mm / 1,57 - 2,36 inch thickness doors.

On demand, it is also possible to provide spindles for the following door panel thicknesses:

30-50 mm / 1,18 – 1,97 inch
50-70 mm / 1,97 – 2,76 inch
60-80 mm / 2,36 – 3,15 inch

For the industry sector, Nuda handles can be provided with preassembled spindles for a desired door panel thickness with a single fixing grain.

Quadri per nottolini / *Privacy set spindles*

I nottolini della collezione Nuda sono forniti con un quadro adattabile per spessore pannello porta compreso tra 40 - 55 mm / 1,57 – 2,17 inch.

Su richiesta disponibili anche per spessore pannello porta compreso tra 55 -70 mm / 2,17 – 2,76 inch.

Nuda privacy sets come as standard with a spindle suitable for door panels with a thickness of 40-55 mm / 1,57 – 2,17 inch

On demand, it is also possible to provide privacy set spindles for door panel with a thicknesses of 55 -70 mm / 2,17 – 2,76 inch.

Foratura porta / Door drilling

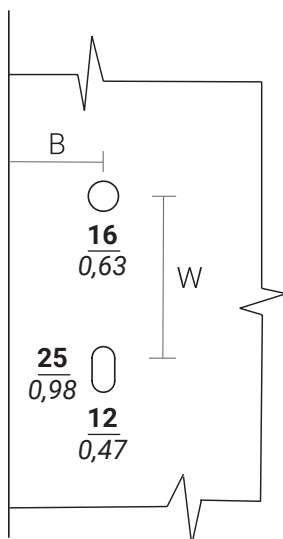
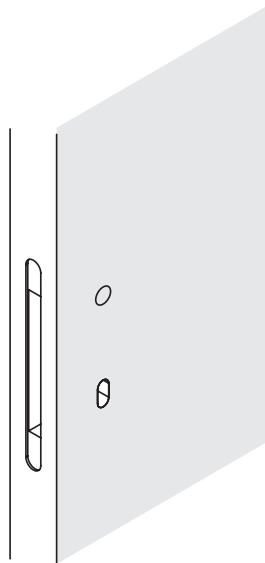

mm
inch

**Maniglia con bocchetta foro chiave standard e slim.
Set pomoli girevoli con bocchetta foro chiave standard o slim.**

*Handle with standard or slim key hole escutcheon.
Turnable knob set with standard or slim key hole escutcheon.*

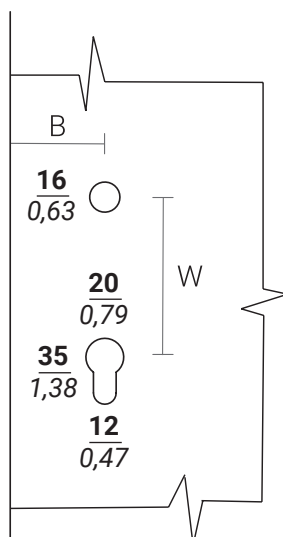
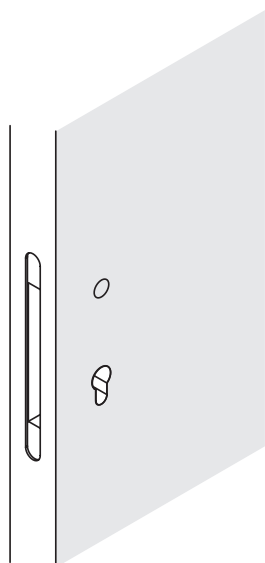

**Maniglia con bocchetta foro cilindro standard e slim.
Set pomoli girevoli con bocchetta foro cilindro standard o slim.**

*Handle with standard or slim cylinder hole escutcheon.
Turnable knob set with standard or slim cylinder hole escutcheon.*

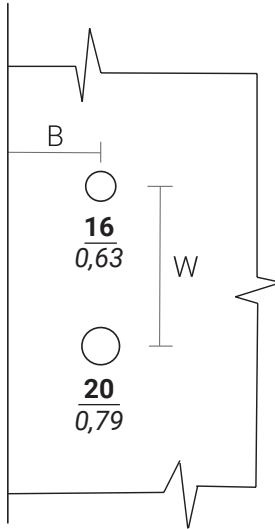
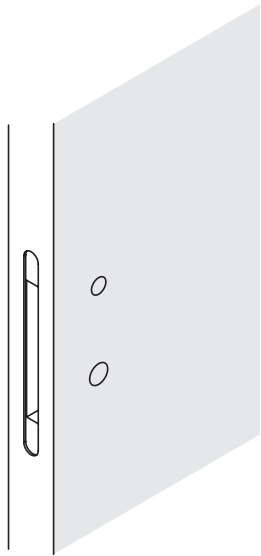

mm
inch

Maniglia con nottolino
mod. Pure/Wind e Atlanta
Set pomoli girevoli con nottolino
mod. Pure/Wind e Atlanta.

Handle with privacy set
mod. Pure/Wind and Atlanta
Turnable knob set with privacy set
mod. Pure/Wind and Atlanta.

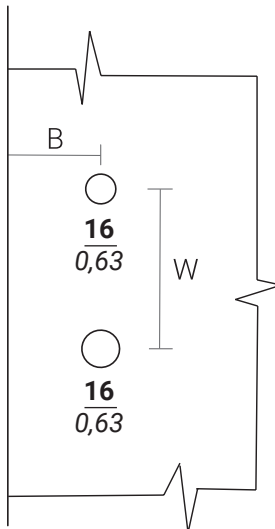
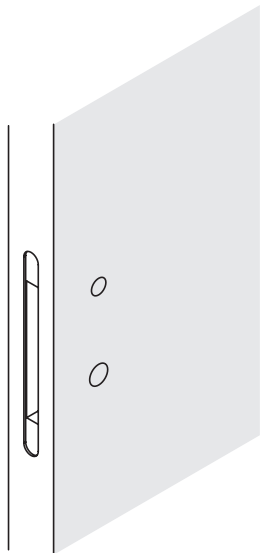

Maniglia con nottolino
mod. Punto
Set pomoli girevoli con nottolino
mod. Punto.

Handle with privacy set
mod. Punto
Turnable knob set with privacy set
mod. Punto.

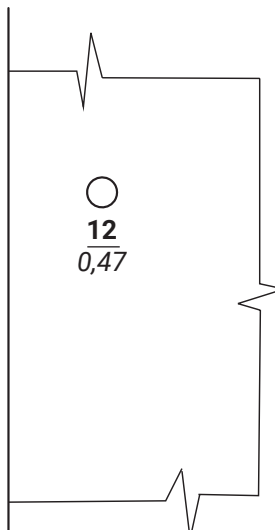
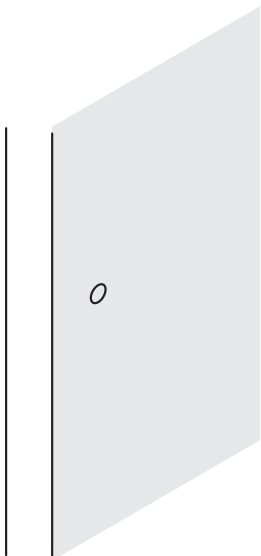

Pomolo fisso singolo/ doppio
Fixed single/ double knob set

Ambienti

Environments

Il minimalismo di Nuda permette di valorizzare ogni ambiente di casa offrendo un tocco di design ricercato in grado di adattarsi ad ogni esigenza.

Nuda can enhance every home environment thanks to its minimalism which offers a refined design able to adapt to every need.



Maniglia mod. Pepe, finitura Cromo Satinato
Maniglia mod. Pepe, finish Satin Chrome





Maniglia mod. Pure, finitura Nero Etna
Maniglia mod. Pure, finish Etna Black





Maniglia mod. Lieve, finitura Cromo Satinato
Maniglia mod. Lieve, finitura Satin Chrome

Nottolino mod. Punto, finitura Cromo Satinato
Privacy set mod. Punto, finish Satin Chrome

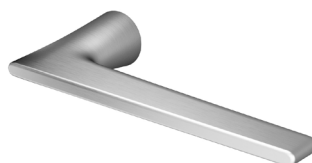



Maniglia mod. Baar, finitura Nero Etna
Maniglia mod. Baar, finish Etna Black



Vetro

Glass



Yoyo

68



Tondo

69



Vulcano sliding

70



Cham sliding

71

Cod. 122009



Finiture / Finishes

cod. 49 Bianco Monviso / *Monviso White*
cod. 80 Grigio Milano / *Milan Grey*
cod. 18 Nero Etna / *Etna Black*

Fissaggio con vite
Fixing with a screw

Dimensioni / Dimensions

mm
inch

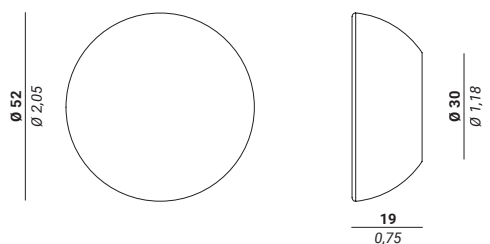

Tondo

Design:
Nuda R&D

Cod. 122010



Finiture / Finishes

cod. 49 Bianco Monviso / *Monviso White*
cod. 80 Grigio Milano / *Milan Grey*
cod. 18 Nero Etna / *Etna Black*

Fissaggio con biadesivo VHB
Fixing with VHB adhesive

Dimensioni / Dimensions

mm
inch

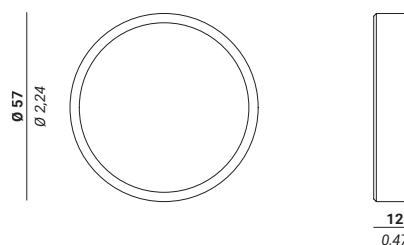

Glass

Vulcano sliding

Design:
Nuda R&D

Cod. 122011



Finiture / Finishes

cod. 49 Bianco Monviso / *Monviso White*
cod. 80 Grigio Milano / *Milan Grey*
cod. 18 Nero Etna / *Etna Black*

Fissaggio con biadesivo VHB
Fixing with VHB adhesive

Dimensioni / Dimensions

mm
inch

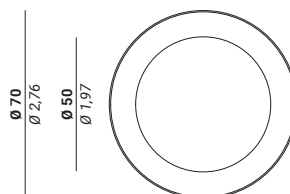

10
0,39

Cham sliding

Design:
Nuda R&D

Cod. 122012



Finiture / Finishes

cod. 49 Bianco Monviso / *Monviso White*
cod. 80 Grigio Milano / *Milan Grey*
cod. 18 Nero Etna / *Etna Black*

Fissaggio con biadesivo VHB
Fixing with VHB adhesive

Dimensioni / Dimensions

mm
inch

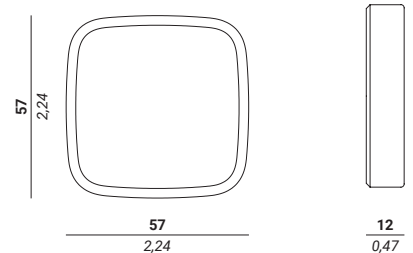

Glass

71

Piastre porte vetro

Glass door plates



Total Glass

74

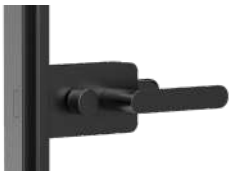

Glass Frame

76



Vulcano Lock

78

Total Glass

Le maniglie Nuda possono essere applicate su porte in vetro grazie all'apposita piastra Total Glass.
Serratura magnetica inclusa nel kit.
Nuda handles can be installed also on glass doors thanks to the specific Total Glass plate.
Magnetic lock included in the kit.

Cod. 13030



Piastra Total Glass versione solo maniglia
Total Glass plate, version only with handle

Spessore vetro 8 mm – 0,31 inch
Glass thickness 8 mm – 0,31 inch

Finiture / Finishes

- cod. 14 Cromo Satinato / *Satin Chrome*
- cod. 49 Bianco Monviso / *Monviso White*
- cod. 18 Nero Etna / *Etna Black*

Materiale / Material

Ottone / Brass

Disponibile nelle seguenti versioni /
Available in the following versions

- Solo maniglia / *Only handle*
Cod. 01
- Maniglia e nottolino Punto /
Handle and Punto privacy set
Cod. 02
- Maniglia e foro cilindro /
Handle and cylinder hole
Cod. 03

Dimensioni / *Dimensions* **mm**
inch

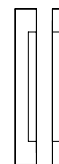
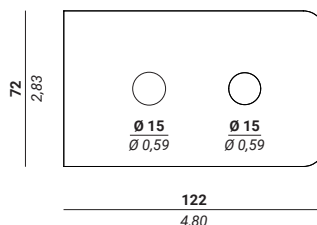

10 3
0,39 0,12

Piastra Total Glass versione con maniglia e nottolino Punto
Total Glass plate with handle and Punto privacy set



Dimensioni contropiastra /
Dimensions counterplate

mm
inch

Contropiastra / Counterplate
Cod. 128030

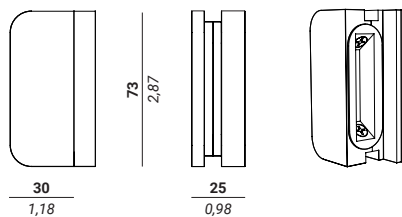

Glass Frame

Per porte in vetro con profilo in alluminio con o senza battuta è possibile realizzare su misura la piastra Glass Frame.
Serratura magnetica inclusa nel kit.
For glass doors with aluminium profile (with or without strike) it is possible to realize Glass Frame plate on demand.
Magnetic lock included in the kit.

Cod. 13040

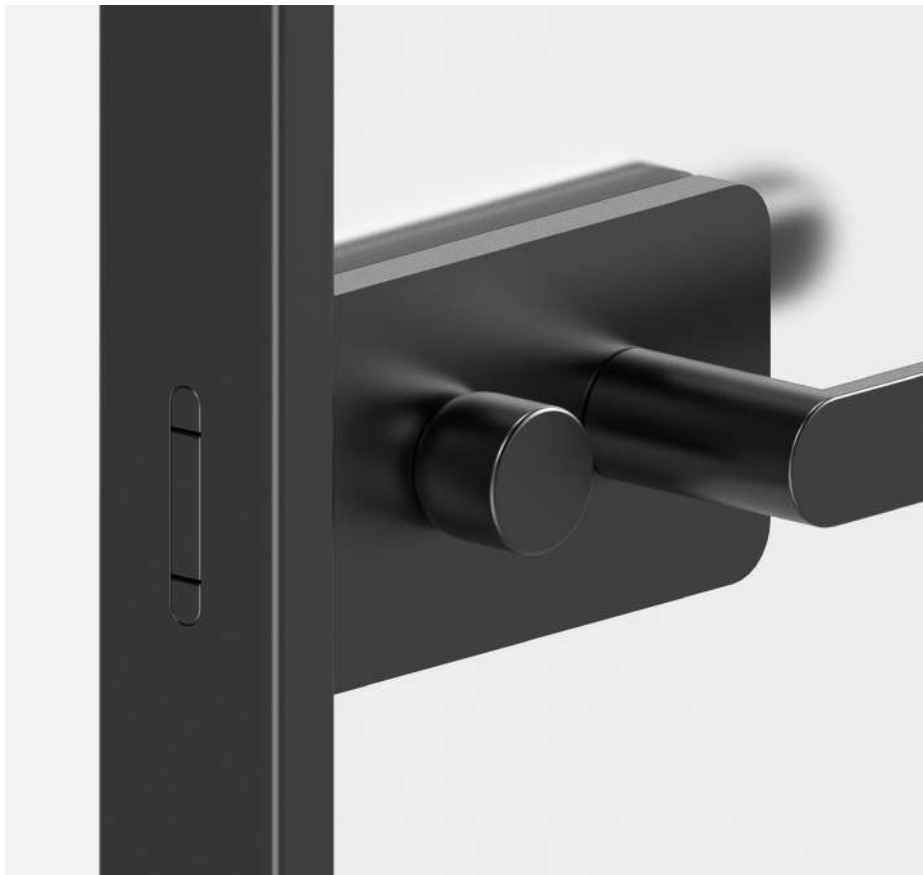

Piastra Glass Frame senza battuta. Versione maniglia con nottolino Punto
Glass Frame plate with strike. Handle and Punto privacy set version

Spessore vetro 6 mm - 0,24 inch
Glass thickness 6 mm - 0,24 inch

Finiture / Finishes

- cod. 14 Cromo Satinato /
Satin Chrome
- cod. 49 Bianco Monviso /
Monviso White
- cod. 18 Nero Etna /
Etna Black

Materiale / Material

Ottone / Brass

Disponibile nelle seguenti versioni /
Available in the following versions

- Solo maniglia / Only handle
Cod. 01
- Maniglia e nottolino Punto /
Handle and Punto privacy set
Cod. 02
- Maniglia e foro cilindro /
Handle and cylinder hole
Cod. 03

Dimensioni / Dimensions

mm
inch

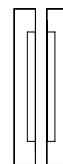
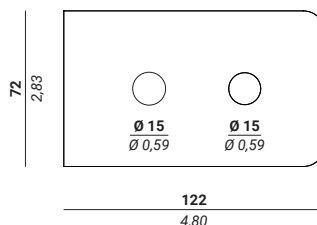

10 10
0,39 0,39

Piastra Glass Frame con battuta. Versione solo maniglia
Glass Frame plate with strike. Version with only handle

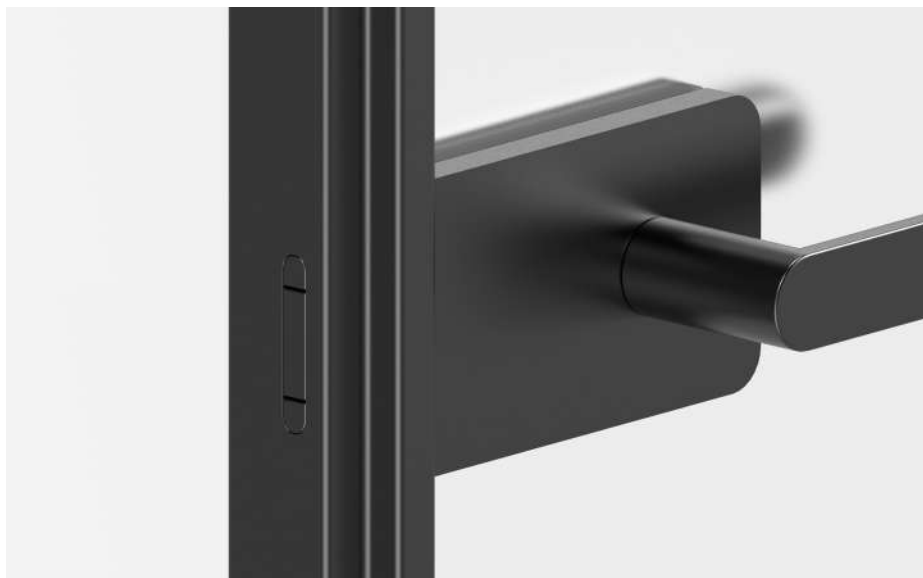

Piastra Glass Frame senza battuta. Versione maniglia con foro cilindro
Glass Frame plate without strike. Handle and cylinder hole version

Vulcano Lock

Piastra per vetro con serratura e sistema push & pull per trascinamento dell'anta.
 Utilizzabile su porte scorrevoli in vetro con o senza profilo in alluminio.
 Glass plate with lock and push & pull system to easily slide the glass door.
 For glass sliding doors with or without aluminium profile.



Spessore vetro versione con profilo alluminio 6 mm – 0,24 inch
 Glass thickness with aluminium profile 6 mm – 0,24 inch

Spessore vetro senza profilo alluminio 8 mm – 0,31 inch
 Glass thickness without aluminium profile 8 mm – 0,31 inch

Finiture / Finishes

- cod. 80 Grigio Milano / Milan Grey
- cod. 49 Bianco Monviso / Monviso White
- cod. 18 Nero Etna / Etna Black

Materiale / Material

Alluminio / Aluminium

Disponibile nelle seguenti versioni / Available in the following versions

Porte in vetro senza profilo in alluminio / Glass doors without aluminium profile Cod. 122018

Porte in vetro con profilo in alluminio su request / Glass doors with aluminium profile on request

Dimensioni / Dimensions

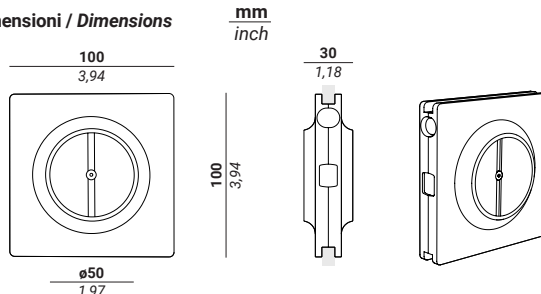



**Dimensioni contropiastra /
Counterplate dimensions**

**mm
inch**

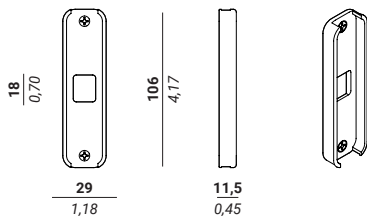

**Contropiastra / Counterplate
Cod. 122019**

Finiture



Bronzo Yester
Yester Bronze



Grigio Milano
Milan Grey



Bianco Monviso
Monviso White



Cromo Lucido
Polished Chrome



Oro 24kt
Gold 24kt



Cromo Satinato
Satin Chrome



Nero Etna
Etna Black

Finishes

Cod.14

Cromo Satinato
Satin Chrome



Cod.39

Cromo Lucido
Polished Chrome



Cod.18

Nero Etna
Etna Black



Finiture speciali su richiesta
Special finishes on demand

Cod.21

Bronzo Yester
Yester Bronze



Cod.49

Bianco Monviso
Monviso White



Cod.80

Grigio Milano
Milan Grey



STOPPINO

**Il modo più facile di
fermare la porta**

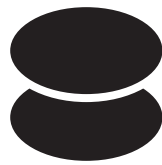

**The easiest way to
stop the door**

Stoppino Open

Stoppino Open è un fermaporte magnetico a pavimento estremamente minimalista sviluppato per porte da interno. Il suo utilizzo evita che la porta sbatta a causa di improvvisi colpi di vento o che possa urtare pareti o mobili in prossimità di quest'ultima.

Stoppino Open si compone di tre elementi: un corpo che viene inserito nel telaio della porta e una base con magnete per il pavimento. Stoppino Open è disponibile in due versioni: il modello 1 si caratterizza per una base dal limitato impatto visivo mentre il modello 2 ha una base con un design peculiare disponibile in diverse finiture. Entrambi le basi possono essere applicate a pavimento tramite biadesivo o con una vite e sono calpestabili. L'applicazione di Stoppino Open con biadesivo è ideale per ambienti con riscaldamento a pavimento o dove non è possibile effettuare fori. Il biadesivo è testato per resistere a situazioni con elevata umidità o temperatura.

Stoppino Open is a concealed magnetic door-stopper developed for interior doors. It prevents the door from opening too far and damaging nearby wall or furniture or slamming because of the wind. Stoppino Open has three main parts: the body to be fixed in the door inner frame and a base with a magnet for the floor. Stoppino Open is available in 2 versions: Model 1 has a small base for a low visual impact whereas model 2 has a specific design base available in different finishes. Both bases can be fixed to the floor with self-adhesive or with a screw and they are both walkable. The application of Stoppino Open with self-adhesive fixing is suitable for floor heating systems or where it is not possible to drill the floor. The self-adhesive is tested for environments with high humidity or temperature.

Stoppino Open è un sistema meccanico con applicazione magnetica di fermo per porte che permette di bloccare la porta in posizione di apertura.

***Stoppino Open is a mechanical door-stopper with magnets.
It allows to leave the door in the open position.***

Calpestabile

**Fissaggio base a pavimento
con biadesivo o piccola vite**

Nessun foro invasivo a pavimento

Prodotto in Italia

Walkable

**The base can be fixed to the floor
with adhesive or a small screw**

No invasive holes in the floor

Made in Italy

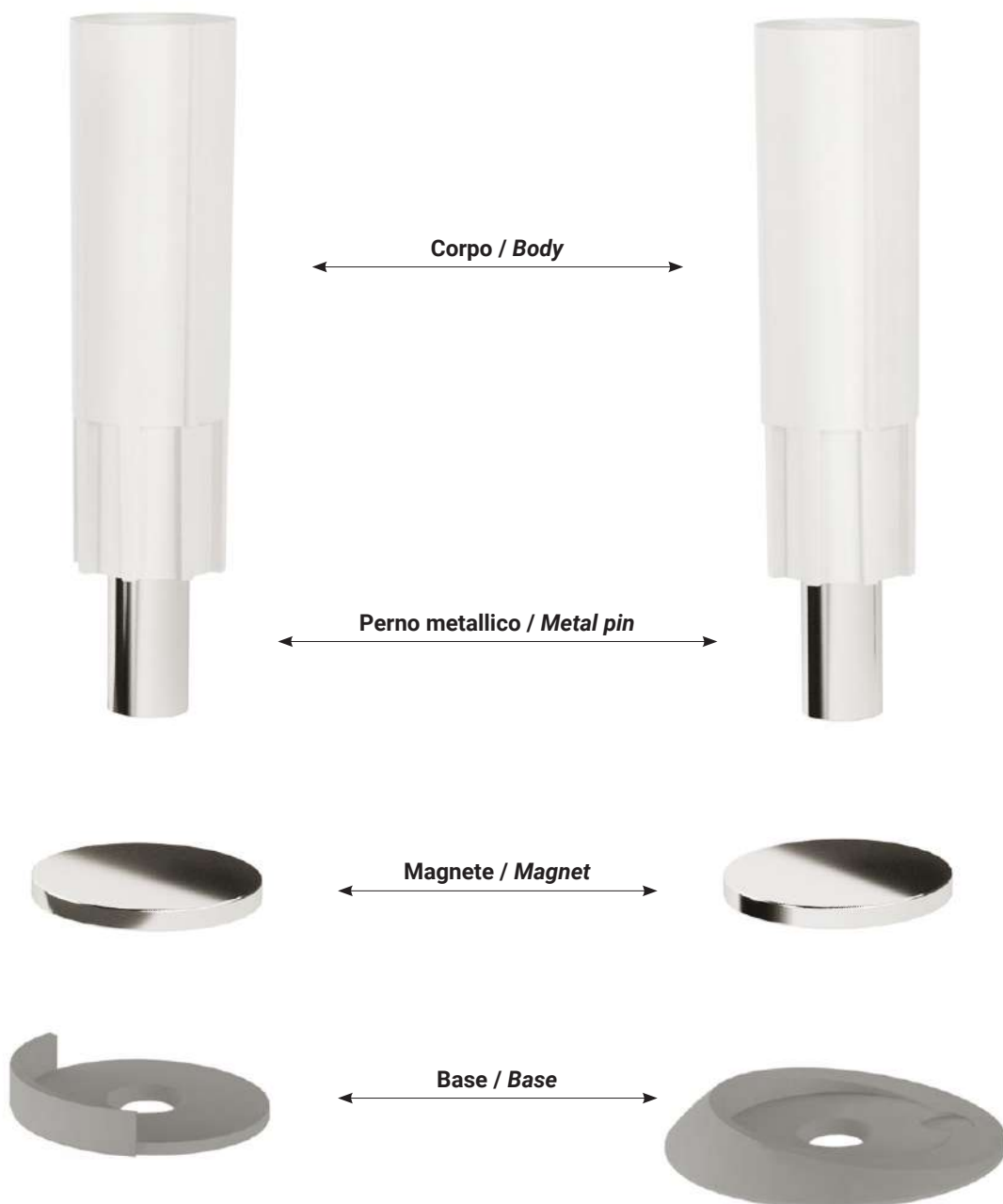

Base applicabile a pavimento con biadesivo o con vite. Si consiglia l'applicazione del corpo di Stoppino Open nel telaio della porta per un corretto funzionamento.

Floor mounted base with self-adhesive fixing or with a screw. It is highly recommended to install Stoppino Open body in the door wooden frame to ensure a proper functioning.

- Distanza min. (porta-pavimento)
5 mm / 0,20 inch
- Distanza max. (porta-pavimento)
14 mm / 0,55 inch

- *Minimum gap (door-floor)*
5 mm / 0,20 inch
- *Maximum gap (door-floor)*
14 mm / 0,55 inch

Stoppino Open Mod. 1

Cod. 160901



Finitura Magnete : Cromo Lucido
Magnet Finish : Polished Chrome

Finitura base : Zincato Bianco
Base finish : White Zinc

Fermaporta magnetico interno

Internal magnetic door stopper

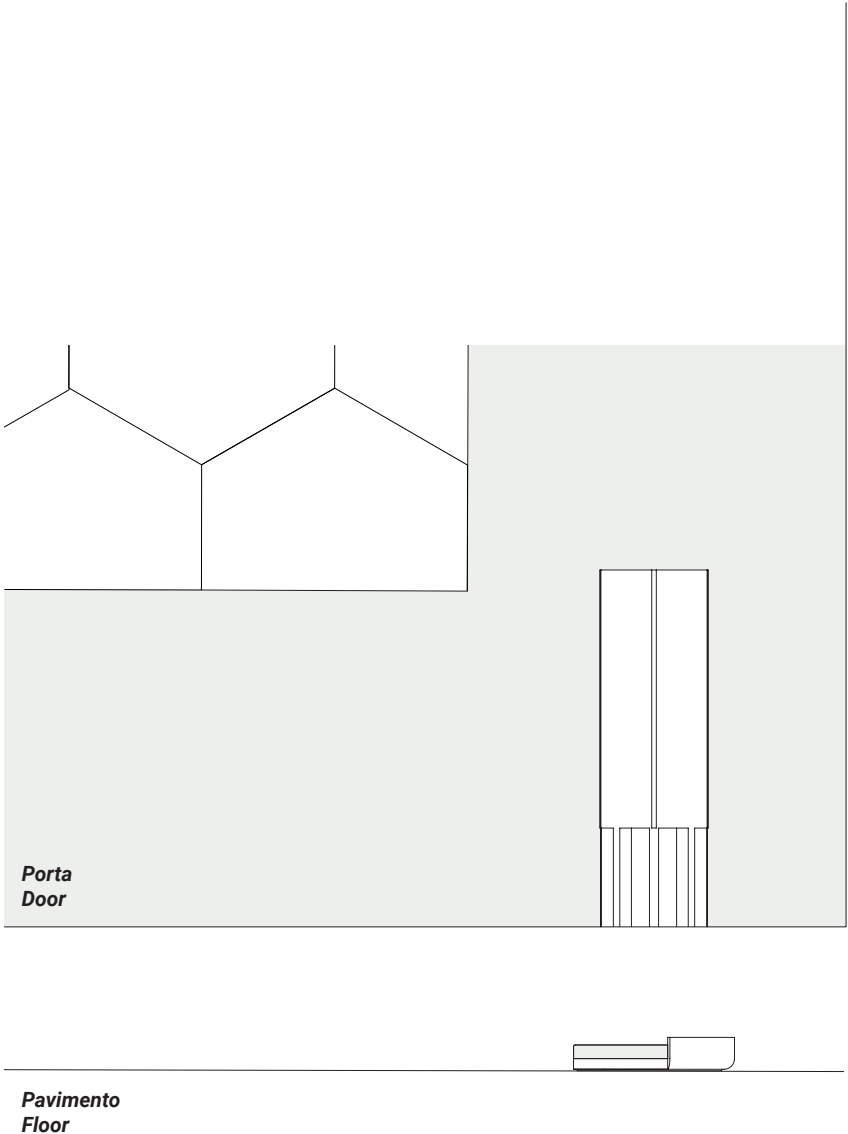

5 - 14
0,20 - 0,55

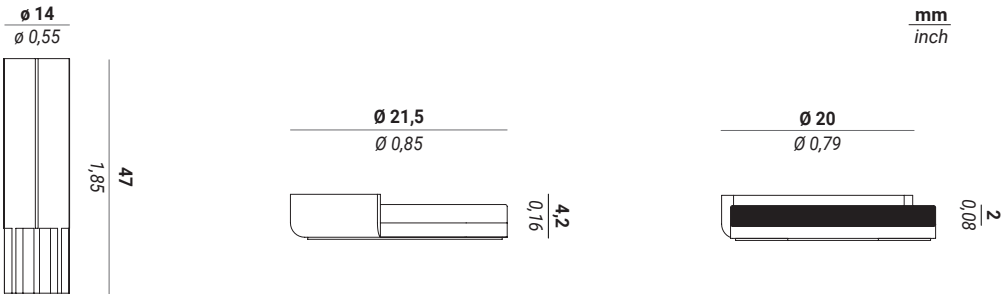

Stoppino Open Mod. 2

Cod. 160902



Finitura Magnete : Cromo Lucido
Magnet Finish : Polished Chrome

Finiture base / Base finishes



cod. 18
Nero
Black



cod. 49
Bianco
White



cod. 14
Grigio Opaco
Matt Grey



cod. 37
Ottonato Lucido
Polished Brass

Fermaporta magnetico interno

Internal magnetic door stopper

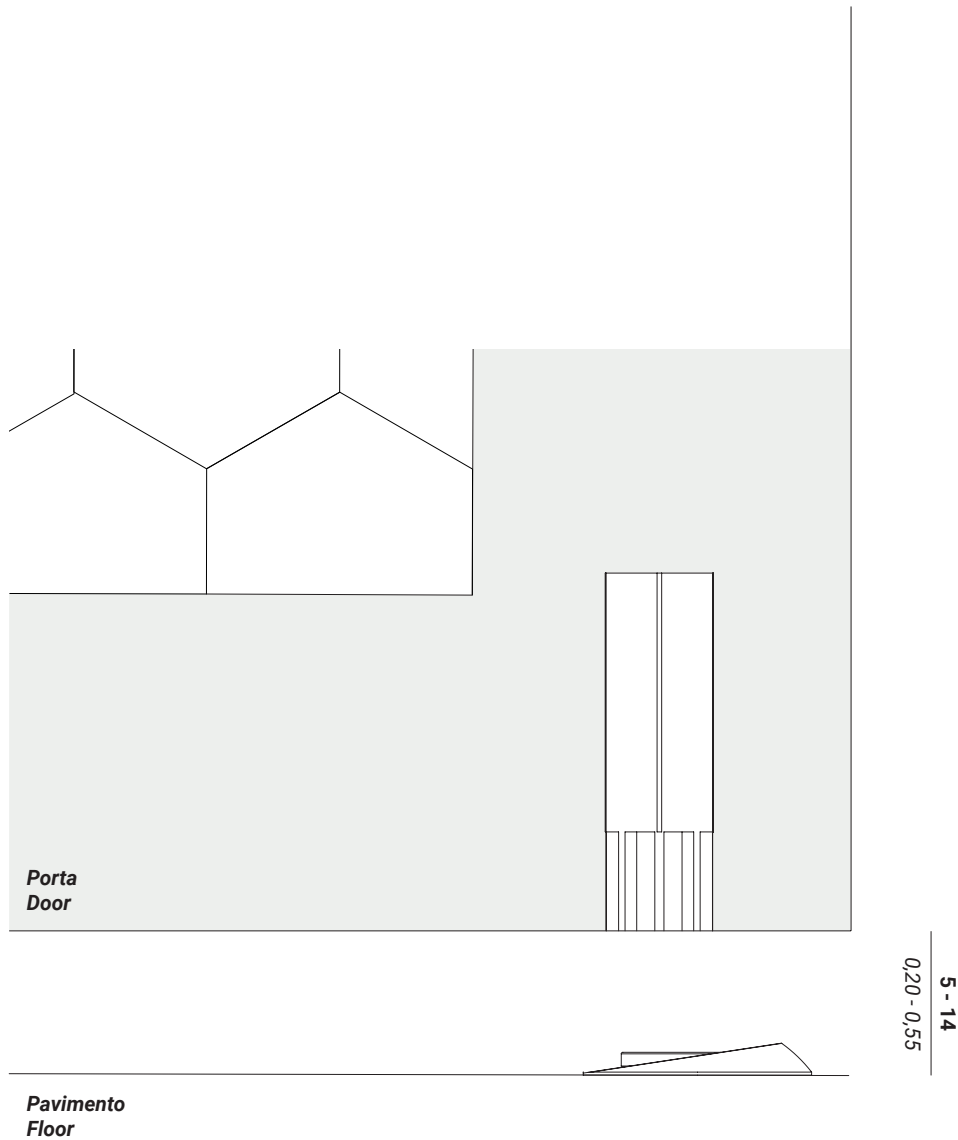

Disponibile versione con base altezza 5 mm - 0,20 inch. /Version with 5 mm - 0,20 inch high base available

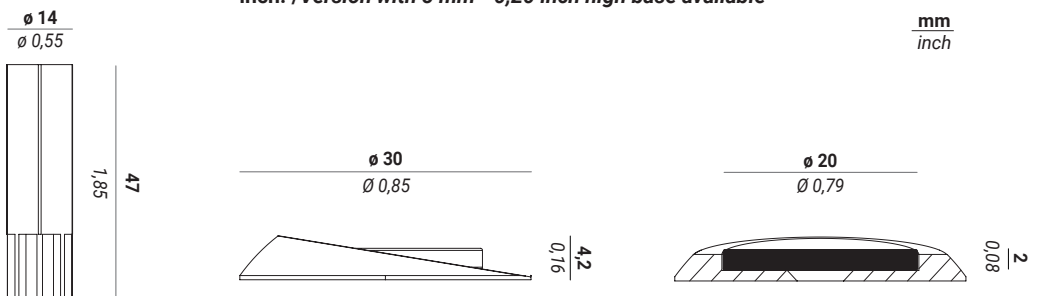

Stoppino X

Stoppino X è un fermaporte magnetico esterno da applicare direttamente sul pannello porta tramite biadesivo o con viti nascoste. Semplicità e rapidità di montaggio direttamente sulla porta già installata. Stoppino X ha una base dal design calpestabile e si applica a pavimento tramite biadesivo o con una vite.

Stoppino X is an external magnetic door stopper to be applied directly on the door panel with adhesive or with hidden screws. Simple and quick fixing on the door already installed. Stoppino X has a specific design walkable base that can be fixed to the floor with self-adhesive or with a screw.

Stoppino X è un fermaporte magnetico esterno da applicare direttamente sul pannello porta tramite biadesivo o con viti nascoste.

Stoppino X is an external magnetic door stopper to be applied directly on the door panel with adhesive or with hidden screws.

Calpestabile

**Fissaggio base a pavimento
con biadesivo o piccola vite**

Nessun foro invasivo a pavimento

**Corpo montabile direttamente sulla
porta con biadesivo o viti nascoste**

Prodotto in Italia

Walkable

**The base can be fixed to the floor
with adhesive or a small screw**

No invasive holes in the floor

**The body can be installed directly on the
door panel with adhesive or with
concealed screws**

Made in Italy

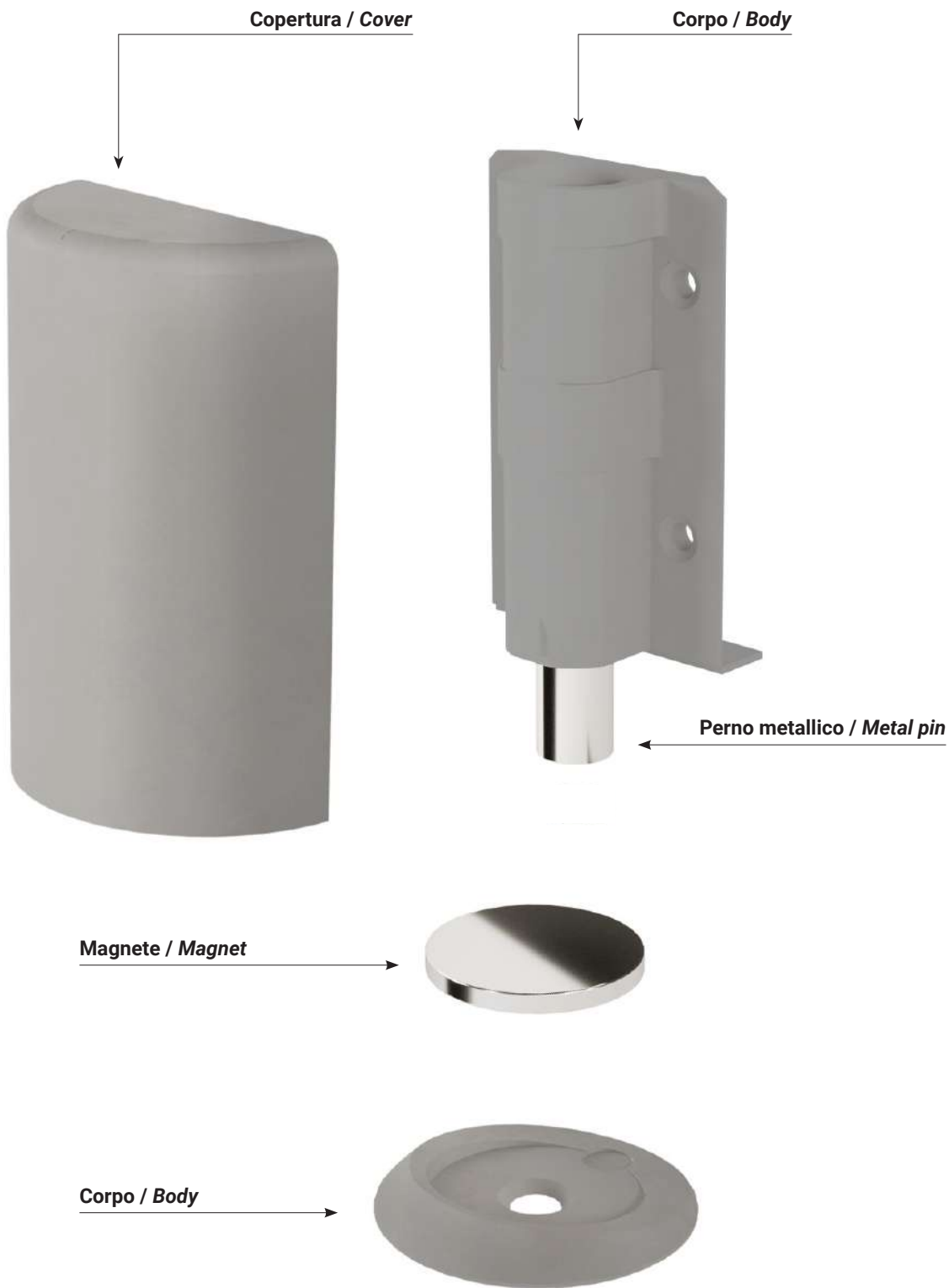

Stoppino X

Cod. 160905



Fissabile a pannello porta con biadesivo o con viti nascoste/
It can be applied to the door panel with adhesive or with concealed screws

Finitura Magnete : Cromo Lucido
Magnet Finish : Polished Chrome

Finiture base e corpo / *Base and body finishes*

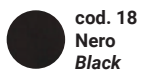

cod. 18
Nero
Black



cod. 49
Bianco
White



cod. 14
Grigio Opaco
Matt Grey

Fermaporta magnetico esterno

External magnetic door stopper

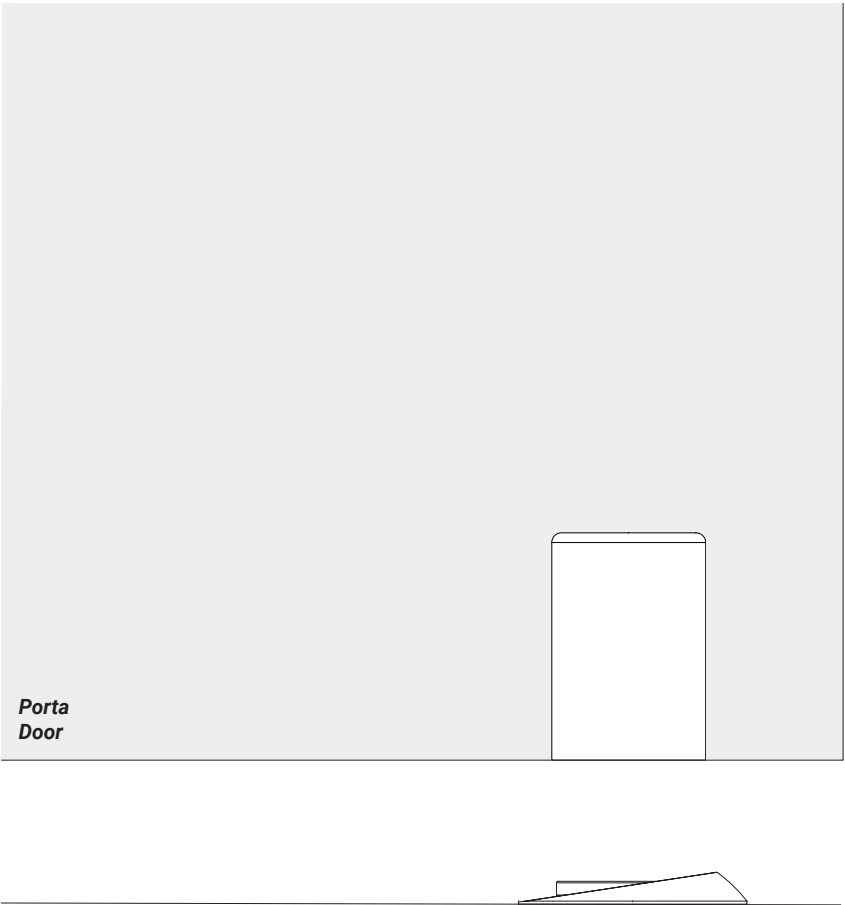

Pavimento
Floor

5 - 14
0,20 - 0,55

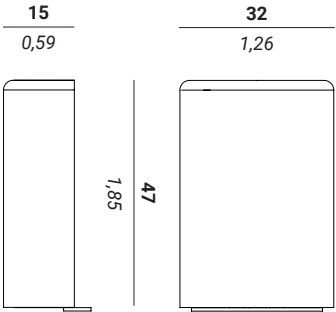

Disponibile versione con base altezza 5 mm - 0,20
Version with 5 mm - 0,20 inch high base available

mm
inch

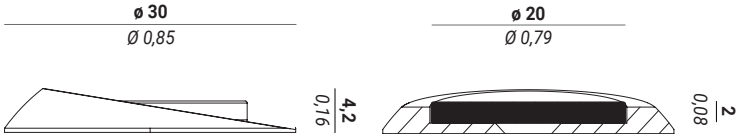

Stoppino Close

Stoppino Close è un sistema di chiusura per porte senza l'utilizzo di tradizionali serrature. Grazie al sistema con due magneti è possibile tenere l'anta in posizione di chiusura in qualsiasi situazione.

I magneti permettono inoltre di eliminare qualsiasi rumore avvicinando o allontanando l'anta. L'installazione è altrettanto semplice ed immediata grazie agli scodellini che permettono di mantenere in posizione corretta i magneti e agendo su una vite di regolarne l'attrazione. Stoppino Close scompare completamente alla vista quando la porta viene chiusa. Per una soluzione ancor più minimalista è possibile applicare i magneti all'estremità superiore della porta, ottenendo così una pulizia completa dello stipite e del profilo della porta, eliminando invasive serrature. Stoppino Close è utilizzabile su ante in legno e su cornici d'alluminio.

Stoppino Close is a closing system for doors without traditional locks. Thanks to a system with two magnets, it is possible to keep the door shut in any situation. Moreover, there is no noise when opening and closing the door. Installation is quick and easy since the housing cups provided set automatically magnets in the correct position and with a screw you can adjust the attraction force.

Stoppino Close is completely concealed when the door is closed. Magnets can also be applied on the top of the door for an even more minimalistic solution so that the frame and the side of the door will be completely clean with no visible hardware. Stoppino Close can be applied on wooden and aluminium frame doors.

**Stoppino Close ferma la porta in posizione di chiusura.
E' un sistema di chiusura magnetico per porte
sprovviste di serratura.**

***Stoppino Close keeps the door shut without a lock.
Stoppino Close is a magnetic closing system
for doors without a lock.***

Invisibile sulla porta

Totalmente silenzioso

Regolabile

Brevettato

Prodotto in Italia

Concealed on the door

Completely silent

Adjustable

Patented

Made in Italy

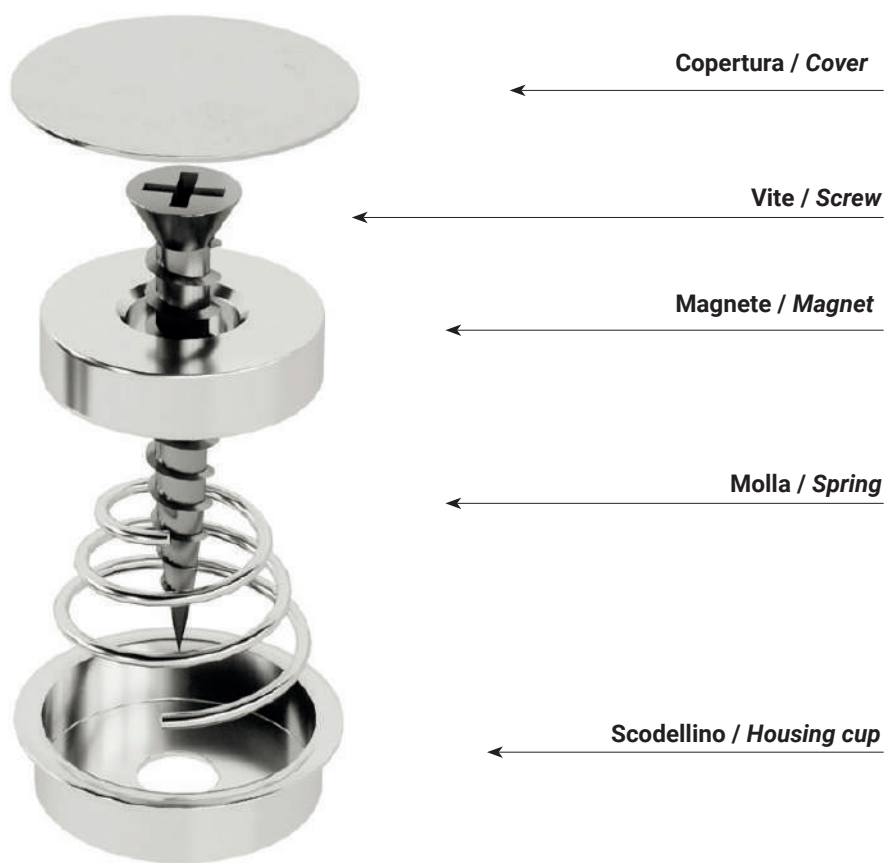
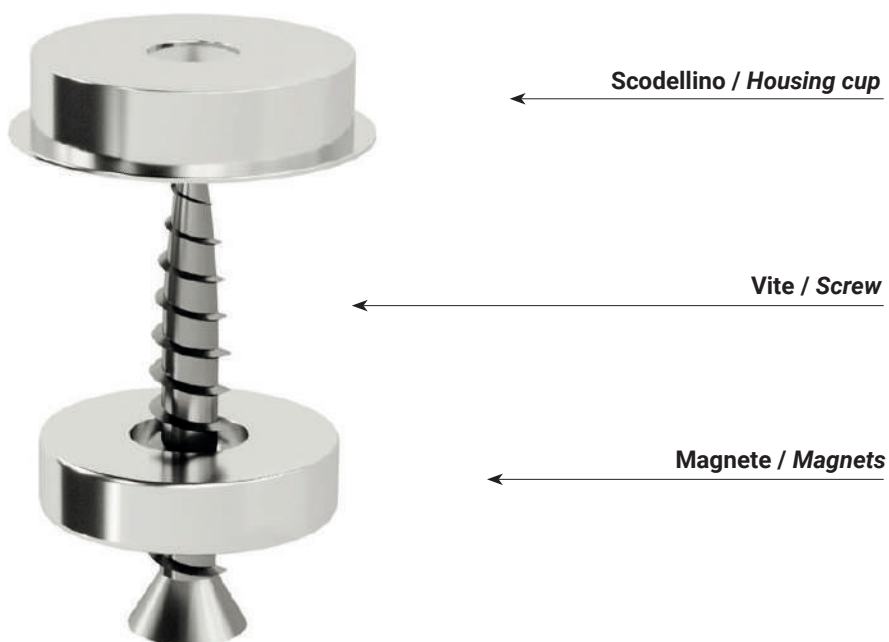

Stoppino Close

Cod. 160904



Per garantire una corretta attrazione:

- Mantenere una distanza minima di 1 mm / 0,04 inch tra i magneti
- Installare il magnete nella porta e nel telaio disassati di circa 10 mm / 0,39 inch
- Per agire sulla forza di attrazione dei magneti, avvitare o svitare la vite

Include una cover coprivite in finitura cromo satinato

To guarantee a correct attraction:

- Keep a minimum distance of 1 mm / 0,04 inch between magnets
- Install the magnet in the door and the one the frame about 10 mm / 0,39 inch off-set
- To adjust the attraction force of the magnets, screw or unscrew the screw

One cover plate in satin chrome finish is included

mm
inch

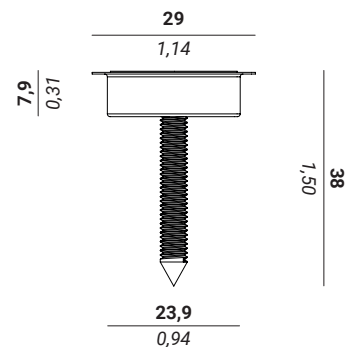

Installazione Standard Standard installation

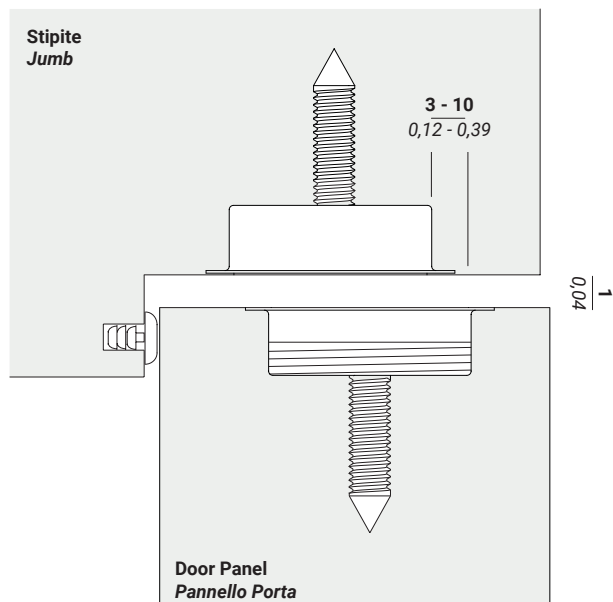

Installazione a scomparsa Concealed installation

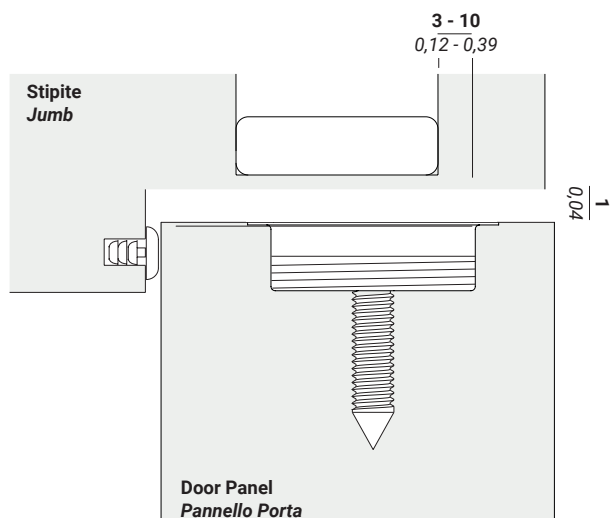

Finiture / Finishes

- cod. 59 Acciaio Satinato / Satin Steel
- cod. 49 Bianco Monviso / Monviso White
- cod. 18 Nero Etna / Etna Black

Profili decorativi

Decorative profiles

Profili decorativi con alluminio in superficie in diverse finiture e molteplici sezioni. L'estrema flessibilità permette di adattarsi alle più diverse forme di applicazione offrendo un tocco elegante e raffinato.



Decorative profiles with a metallic surface in different finishes and multiple cuts. The high flexibility guarantees the adaptation on several kinds of application, adding a unique and refined touch.

mm
inch

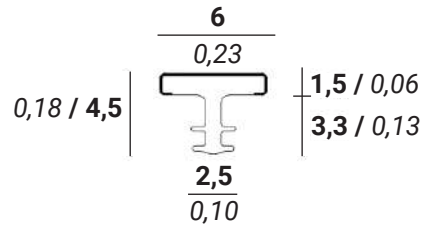

Cod. 150002
Disponibile a stock finitura cod. 39, 07, 02
Available in stock finishes cod. 39, 07, 02

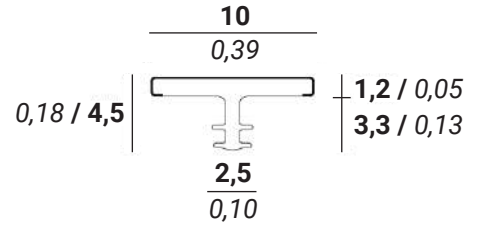

Cod 150008
Disponibile a stock finitura cod. 39, 07, 02
Available in stock finishes cod. 39, 07, 02

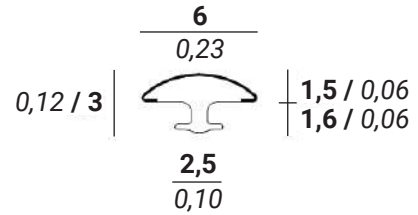

Cod. 150012

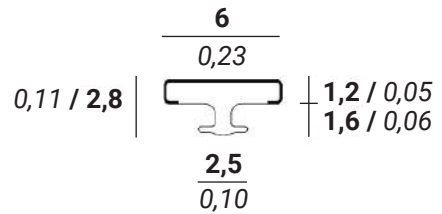

Cod. 150001



Cod.150004

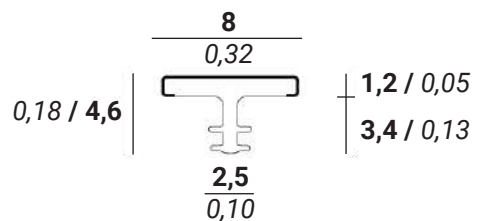

Cod. 150005

mm
inch

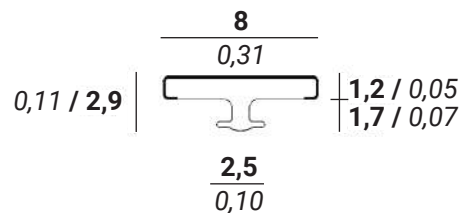

Cod. 150006



Cod. 150007

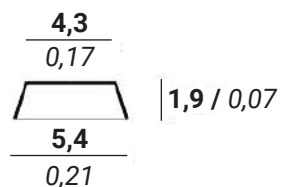

Cod.150011

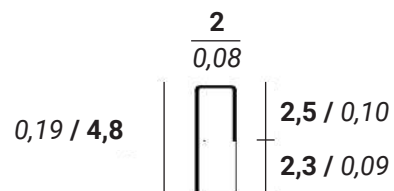

Cod. 150009

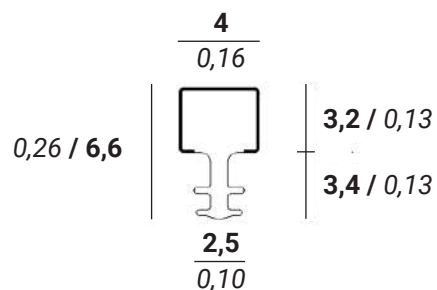

Cod. 150010

mm
inch

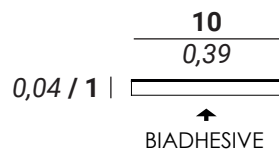
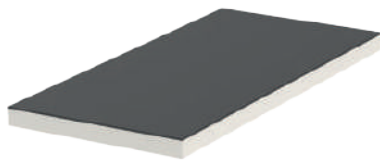

Cod. 150025
Disponibile a stock finitura 69 e 38 nelle texture 00, 04, 05
Available in stock finishes cod. 39,07,02 in textures cod. 00, 04, 05

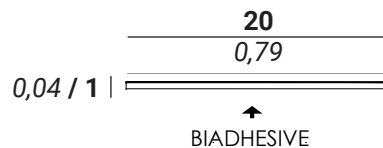
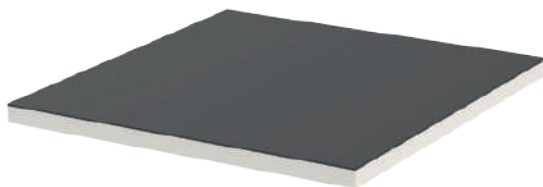

Cod. 150030
Disponibile a stock finitura 69 e 38 nelle texture 00,04, 05
Available in stock finishes cod. 39,07,02 in textures cod. 00, 04, 05

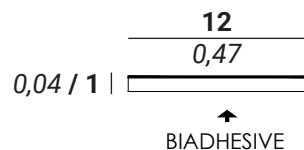
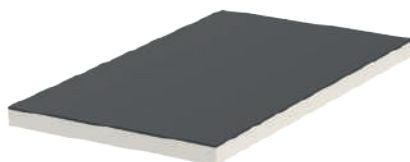

Cod. 150026

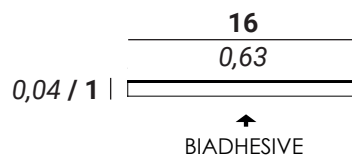
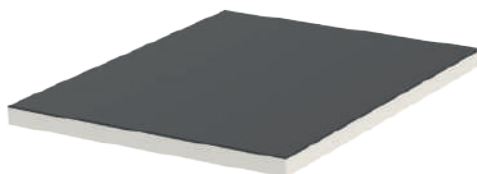

Cod. 150028

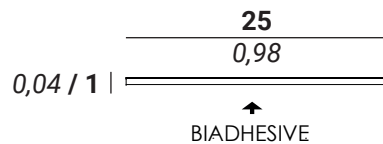
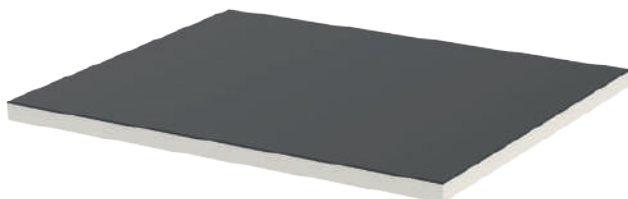

Cod. 150031

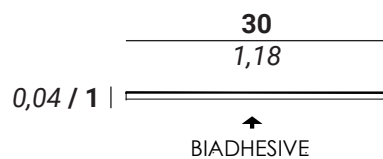

Cod. 150032

Finiture / Finishes

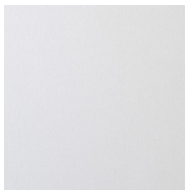

Cod. 39
Cromo lucido
Polished chrome



Cod. 69
Inox spazzolato
Brushed inox



Cod. 02
Oro opaco
Matt gold



Cod. 07
Alluminio spazzolato
Brushed aluminium

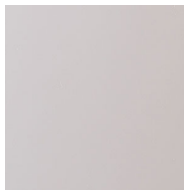

Cod. 67
Alluminio naturale
Natural aluminium

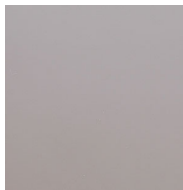

Cod. 60
Acciaio inox
Inox steel

Textures / Textures



Cod. 00
No Texture
No texture

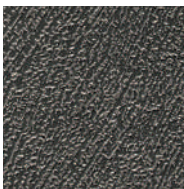

Cod. 01

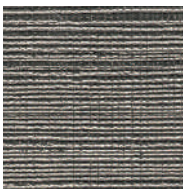

Cod. 02

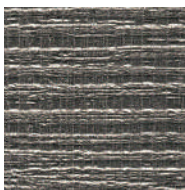

Cod. 03



Cod. 04

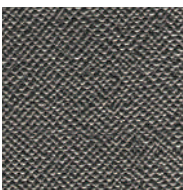

Cod. 05

Espositori commerciali

Commercial displays

Una gamma di espositori per presentare al meglio i prodotti Verum Italy in showroom e spazi espositivi. Soluzioni personalizzabili a pavimento o a banco per adattarsi a tutte le necessità commerciali.

A range of displays to present at best Verum Italy products in every showroom or exhibition space. Floor or counter solutions that can be personalized to adapt to all commercial needs.

Espositore Nuda pavimento / Nuda Floor Display

Cod. 160996

Espositore da banco con 6 modelli a scelta di maniglie o pomoli
Counter display with 6 models of handles or knobs of choice

mm
inch



Espositore Nuda banco / Nuda Counter Display

Cod. 160997

Espositore da banco con 3 modelli a scelta di maniglie o pomoli
Counter display with 3 models of handles or knobs of choice

250
9,84



Espositore Stoppino pavimento Stoppino Floor Display

Cod. 160998

Espositore da pavimento su cui è possibile montare fino a due prodotti tra:
Stoppino Counter floor display with up to two of the following products:

- Stoppino Open o Stoppino X / Stoppino Open or Stoppino X
- Stoppino Close con regolazione / Stoppino Close with regulation

mm	300
inch	11,81



1500
59,06

Espositore Stoppino banco Stoppino Counter Display

Cod. 160999

Espositore da banco su cui è possibile montare fino a due prodotti tra:
Stoppino Counter display with up to two of the following products:

- Stoppino Open o Stoppino X / Stoppino Open or Stoppino X
- Stoppino Close con regolazione / Stoppino Close with regulation

250
9,84



350
13,78

Condizioni generali di vendita

MODELLI, DIMENSIONI, PESI

Verum Italy si riserva, in qualunque momento e senza preavviso, di modificare e/o sopprimere gli articoli del presente catalogo. Dati, misure o schemi su questo catalogo hanno solamente carattere informativo, non sono vincolanti e possono essere soggetti a variazioni.

ORDINI

Verranno accettati solo ordini per iscritto; ordini pervenuti telefonicamente o verbalmente non saranno ritenuti validi. Con la trasmissione dell'ordine il cliente accetta tutte le condizioni elencate di seguito. L'ordine è vincolante per il cliente, mentre impegna Verum Italy solo dopo espressa accettazione. Non possono essere effettuati annullamenti senza l'accordo scritto di Verum Italy, che si riserva comunque di applicare oneri e spese che ne derivino.

TERMINI DI CONSEGNA

I tempi di consegna dell'ordine decorrono dalla data della nostra conferma salvo diversa stipulazione e non potranno in nessun luogo dare luogo ad indennizzo/risarcimento da parte di Verum Italy. I termini di consegna indicati nell'ordine sono da intendersi puramente indicativi e non vincolanti per Verum Italy, che non sarà responsabile di eventuali ritardi. In particolare non è responsabile per ritardata o omessa consegna, totale o parziale, imputabile a cause di forza maggiore, o ad eventi che siano fuori dal suo controllo, quali, in via esemplificativa, scioperi aziendali e di trasporto, mancanza di energia elettrica, mancata o ritardata ricezione di materie prime, ecc. Verum Italy si riserva il diritto di evadere l'ordine anche con spedizioni parziali.

DATI IDENTIFICATIVI DEL CLIENTE

Il cliente è responsabile della comunicazione dei propri dati fiscali forniti in base alla legislazione vigente (Ditta, Ragione sociale, Sede, Partita IVA). I dati del cliente saranno custoditi ed elaborati per adempimenti degli obblighi di Legge. Ogni altro utilizzo dovrà essere espressamente autorizzato dal cliente.

SPEDIZIONI

La merce viaggia a rischio e pericolo del committente franco stabilimento Verum Italy che declina comunque ogni responsabilità per ritardi o rotture verificatesi durante il trasporto. Spetta al committente verificare la merce in arrivo e contestare eventuali danni direttamente al trasportatore, anche se questi è stato scelto da Verum Italy, entro 8 giorni dal ricevimento della stessa mediante raccomandata A.R. Si accettano eventuali reclami sulla quantità di pezzi ricevuta al massimo entro 8 giorni dalla data di consegna.

PAGAMENTO

I pagamenti devono essere effettuati direttamente a Verum Italy nei termini pattuiti. Trascorsi i termini Verum Italy provvederà senza alcun preavviso all'addebito degli interessi di mora stabiliti per Legge, che decorreranno dal giorno immediatamente successivo alla scadenza del debito. Il mancato rispetto dei pagamenti pattuiti, comunicati per iscritto nelle conferme d'ordine, può comportare, a discrezione dell'azienda, il blocco degli ordini in corso fino a pagamento avvenuto e la sospensione delle ulteriori forniture anche se già accettate. I pagamenti dei prodotti già consegnati non saranno subordinati al completamento dell'ordine. Nessun pagamento potrà essere differito nel caso di contestazioni salvo accordi diversi. Fino al momento in cui Verum Italy non abbia ricevuto il pagamento del valore complessivo dei prodotti, gli stessi rimarranno di esclusiva proprietà di Verum Italy.

RESPONSABILITÀ

Non si accettano merci di ritorno se non rese in Porto Franco e preventivamente autorizzate da Verum Italy. Solo il materiale riscontrato difettoso da Verum Italy sarà sostituito gratuitamente senza nessun altro indennizzo per danni, spese o riparazioni. Verum Italy non si assume alcuna responsabilità e alcuna garanzia è prevista per difetti e danni derivanti da installazione impropria o cattivo uso. È vietato agli acquirenti effettuare qualsiasi lavorazione che modifichi le caratteristiche originarie dei prodotti Verum Italy.

CONTROVERSIE

Le forniture sono soggette alla Legge italiana. Per qualunque controversia è riconosciuta la sola ed esclusiva competenza del Foro di Milano, Italia.

TERMINI DI GARANZIA

Si certifica che i prodotti Verum Italy sono interamente prodotti in Italia nelle nostre Aziende, salvo dove espressamente indicato. Ogni articolo, stampato o fuso e lavorato a mano è unico ed irripetibile e le piccole differenze cromatiche, che possono riscontrarsi, rappresentano la garanzia più certa dell'artigianalità del prodotto. Eventuali imperfezioni e/o differenze nella forma, nelle finiture e nei materiali sono da attribuire alla tecnologia e/o alle operazioni manuali necessarie alla lavorazione del prodotto. L'inosservanza delle istruzioni di montaggio e/o una non cura nell'utilizzo dei prodotti Verum Italy possono causare il mal funzionamento per i quali si declina ogni responsabilità.

CONSIGLI PER LA PULIZIA, LA CURA E LA MANUTENZIONE DEL PRODOTTO

Si consiglia di pulire i prodotti Verum Italy utilizzando solamente un panno asciutto o leggermente inumidito con acqua. Non utilizzare assolutamente alcun detergente chimico per non alterare l'efficacia del trattamento superficiale.

General sales terms and conditions

MODELS, DIMENSIONS AND WEIGHTS

Verum Italy reserves the right, at any time, to change and/or to cancel the items of this catalogue. Information, size or drawings in this catalogue are only for information and are not binding.

ORDERS

Orders are accepted only in written form; orders or modifications communicated verbally and/or by phone will not be valid. Customers accept and are aware that their order is subject to the following general sale terms and conditions. Verum Italy is not legally bound by an order until we have confirmed it in written form but the Customer is bound when he/she accepts it. No cancellation of the order is valid without written agreement from Verum Italy Srl, which reserves the right to apply charges.

DELIVERY TERMS

Delivery time starts from the order confirmation date, unless otherwise agreed, Verum Italy Srl will not recognize any indemnity or compensation. The order delivery terms are purely indicative and not binding for Verum Italy Srl, which is not responsible for any delay. Verum Italy is not liable for delayed or skipped delivery in its totality or partiality, due to acts of God or other event out of its control, like for example labour or freight strikes, lack of electric energy, missed or delayed raw material receipt and so on. Verum Italy reserves the right to dispatch orders even with partial shipment.

CUSTOMER INFORMATION

The Customer is responsible for all the identification information data requested by the legislation in effect (Company name, legal name, Address, VAT, etc.). All Customer's data will be kept and used in full compliance with the Italian Law. All other use must be specifically allowed by the Customer.

DELIVERIES

Ordered goods will be at the Customer's risk from the moment of delivery so Verum Italy declines any responsibility for delays or damage caused during the shipment. The Customer is responsible for checking the delivered goods and reporting possible damage to the forwarder, even if chosen by Verum Italy, within 8 (eight) days from receipt by certified mail. The Customer is also responsible for checking the quantity of the delivered goods; claims about quantity will only be accepted within 8 (eight) days from receipt.

PAYMENTS

Payments shall be made directly to Verum Italy Srl in the manner and at the time agreed by the parties. In the event of failure to make the payment at the due date, the Customer will, with effect from the invoice date, be charged of interests and penalties. If the Customer is in default, Verum Italy shall have the right to defer shipment or any future order intake or delivery until such default is remedied or said credit reestablished to our satisfaction. No claim shall enable the customer to suspend payments. The payment of products already delivered shall not oblige Verum Italy to complete the order. In case of disagreements payments cannot be deferred, unless otherwise agreed. Until the receipt of payment for the total value of the goods ordered, Verum Italy will be and remain the sole and only proprietor of the goods.

RESPONSABILITY

Verum Italy does not accept return of goods without prior approval, in all cases costs for goods returns must be borne by the Customer. Only faulty goods found by Verum Italy Srl will be replaced free of charge without any other indemnity or refund for damage or repairs. Verum Italy is not responsible for any faulty goods which have been manipulated in a bad way. Any damage caused by improper installation or use is not covered by any guarantee. Customers are not authorized to rework Verum Italy products.

CONTROVERSY

Orders are governed by the Italian Law. If the parties cannot reach amicable settlements, disputes shall be referred uniquely to the competent civil court in Milano.

WARRANTY

We certify with our complete and utmost corporate integrity that Verum Italy products are produced solely within our Italian manufacturing facilities, if not expressly indicated. Each piece of hardware, forged or cast is hand-crafted to perfect the uniqueness in design and finish. The guarantee of originality is due to the fact that the finish of each product is slightly different than the previous item. Any imperfections or differences in form, finishes and materials are to be attributed to the technology or manual operations necessary for processing the product. Failure to comply with the instructions and /or a lack of care in use may cause damages for which Verum Italy declines all responsibility.

CLEANING SUGGESTIONS

In order to maintain the quality of the protective treatment and uniqueness of all finishes of Verum Italy products do not attempt to clean with detergents and/or chemicals. Hence, simply use a lightly water moistened cloth to clean the items.

Verum Italy

Strada Statale Briantea, 40
23892 Bulciago LC
Italia

+39 031 355 9009
info@verumitaly.it

VERUM
ITALY